



DuraHold[®]
segmental retaining wall

Installation Guide



RisiStone[®]
retaining wall systems

Risi Stone Systems
8500 Leslie Street, Suite 390
Thornhill, ON L3T 7M8 Canada
© 2007 by Risi Stone Systems
All rights reserved. Published 2007
Printed in Canada

Risi Stone Systems has attempted to ensure that all information contained in this guide is correct. However, there is the possibility that this guide may contain errors. Review all designs with your local sales representative prior to construction. Final determination of the suitability of any information or material is the sole responsibility of the user.



RisiStone
retaining wall systems

Toll-free: 1-800-626-WALL (9255)
Fax: 905-882-4556
Email: info@risistone.com
Web: www.risistone.com



contents

Introduction	4
the DuraHold system	5
unit details	7
overview of a successful project	8
following the design	9
Installation	11
single-depth installation procedure	12
single crib installation procedure	15
double crib installation procedure	18
reinforced srw installation procedure	20
alternate reinforced fill materials	23
vertical walls	24
Details	25
outside corners	26
inside corners	31
curves	37
fences	39
obstructions	41
internal drainage	42
external drainage	43
steps	46
terraces	48
finishing details	49
Specifications	50
Glossary	67



Introduction

- the durahold system5
- block details7
- overview of a successful project8
- following the design9





The DuraHold system is a solid, modular concrete retaining wall system that is used to stabilize and contain earth embankments, large or small. Today, the DuraHold system and several other retaining wall systems licensed by Risi Stone Systems are manufactured and installed across North America and internationally.

In the DuraHold system, the facing is constructed from a single mass-produced modular unit. Because the units are solid, they can be modified by cutting. Specialized units like coping and corner units are available to help speed the installation of wall features. The DuraHold system can be constructed in three basic configurations: a DuraHold Single-Depth Conventional SRW, a DuraHold Geogrid Reinforced SRW, or a DuraHold Crib SRW.

There are many applications for DuraHold retaining walls. Most examples can be divided into the three aforementioned configurations which, more or less, follow two basic uses: landscape applications and structural applications.

In landscape applications, the primary purpose of retaining walls is aesthetic in nature. Some examples of DuraHold landscape uses are water and terraced applications. Most landscape applications call for walls under 1.2 m (4 ft) in height, with minimal loads being applied to the wall. Consequently, most landscape walls are built as conventional SRWs.

In structural applications, the primary function of retaining walls is to provide structure and strength to steep slopes or cuts. Some common structural uses for DuraHold retaining walls are high walls, some in excess of 7.5 m (25 ft); walls required to support parking, roads, or highways; and erosion protection along streams or lakes. In most of these cases, geosynthetic reinforcement is used or a crib structure is required. Crib SRWs utilize tieback and deadman units to increase the maximum allowable wall height. This configuration is particularly useful for construction in tight spaces (e.g. close to a property line).

The DuraHold system is supported by local manufacturers and Risi Stone Systems. Local manufacturers will make every attempt to answer general questions and they will gladly provide customers with answers for site-specific applications. Each location has access to prepared information on the DuraHold system and has plenty of experience installing it. The RisiWall design software also helps to provide solutions for specific site designs. Unique applications often necessitate the assistance of a Professional Engineer. Risi Stone Systems can provide these solutions through its Engineering Design Assistance program.

features & benefits

The DuraHold system has a number of features that make it unique. Each of these features has been developed to give a DuraHold retaining wall the advantages of increased beauty, simplified installation, and greater strength. These features benefit the owner by lowering the entire cost of the retaining wall, both during installation and well into the future.

Modular Retaining Wall System

Wall is flexible, yet retains its structural characteristics.

- Walls absorb minor movements due to frost or settlement.
- Requires minimal embedment below grade.

A compacted granular base is all that is required.

- Reduces cost by not requiring an expensive structural footing.

Solid Unit Manufactured From 35 MPa (5000 psi) Concrete

Provides wall with greater durability.

- Ensures the maximum weight of each unit because there are no voids or cores to be filled.
- Less susceptible to freeze-thaw deterioration.
- Less likely to be broken by handling or in transit.

Solid units are easy to modify.

- Can create site-specific features using the modular units.

No hollows to be filled with gravel and compacted.

- Ensures maximum resistance to overturning forces.
- Saves time and money.

Tongue and Groove Interlock

Interlocking mechanism molded into the units so there are no separate pins or clips.

- No need to incorporate multiple components; installation rates increase.
- Ensures maximum shear connection between units.

Units are dry-stacked.

- Lower costs because no mortar is used in the construction.
- Minimal training is required to achieve excellent results.

Units are self-aligning and self-battering.

- Once the first course is laid flat and levelled, subsequent courses automatically align horizontally and vertically.

Creates a continuous interlock throughout the wall.

- Makes a stronger, more damage-resistant wall.

Size and Weight

The DuraHold units range in weight from 395kg (870lbs) up to 790kg (1740lbs). As a result, these units must be machine-placed.

DuraHold with Geogrid Reinforcement

Ability to construct higher walls.

- Can utilize site soil as infill, consequently lowering disposal and extra material charges.
- Can use the same facia throughout a site on lower conventional SRWs, and higher geogrid reinforced SRWs.

Choice of Configurations

- Walls on one site with different structural requirements can have the same appearance.

DuraHold Crib Structure

Ability to construct higher walls.

- Can be used in areas of reduced space (e.g. close to a property line).
- Can be incorporated with lower conventional SRWs and higher geogrid-reinforced SRWs while maintaining the same appearance.

Choice of Configurations

- Walls on one site with different structural requirements can have the same facia.

90° and 45° Corner Units

Manufactured to speed construction.

- Offers a finished appearance to the wall.
- Initiates the correct running bond pattern.
- Increases the strength of corners.
- Saves time during installation.

Complementing Accessories

All the standard features for retaining walls can be supplied by the manufacturer.

- Saves time during installation.
- Creates a uniform, finished look for the wall.

Technical Support and Engineering Design Assistance

Technical expertise developed over thirty years through experience and testing is available to customers.

- Ensures that retaining walls are correctly designed and constructed.
- Advanced software is available to help designers generate designs for stable retaining wall structures.



unit details

Due to local conditions and preferences, the licensed manufacturer may produce the DuraHold system with one or more minor variances. These differences in no way affect the performance of the wall.

colours

DuraHold is manufactured in a standard grey colour, but minor variation may be due to concrete mixes. Special-order colours may be available in some locations.

closed-end coping

Some manufacturers produce closed-end coping units that can be used to hide the groove in the bottom of the coping unit at locations where the retaining wall steps up or down.

DuraHold System Units	Face Width	Back Width	Height	Depth	Mass
 Standard Unit	72 in	72 in	12 in	24 in	1610 lbs
	1830 mm	1830 mm	305 mm	610 mm	732 kg
 Tapered Half Unit	36 in	34 in	12 in	24 in	771 lbs
	915 mm	876 mm	305 mm	610 mm	350 kg
 90° Corner Unit	60 in	60 in	12 in	24 in	1363 lbs
	1525 mm	1525 mm	305 mm	610 mm	620 kg
 45° Corner Unit	60 in	60 in	12 in	24 in	1422 lbs
	1525 mm	1525 mm	305 mm	610 mm	646 kg
 Tieback Unit	72 in	72 in	12 in	24 in	1650 lbs
	1830 mm	1830 mm	305 mm	610 mm	750 kg
 Coping Unit	72 in	72 in	12 in	24 in	1568 lbs
	1830 mm	1830 mm	305 mm	610 mm	713 kg
 Half Coping Unit	36 in	36 in	12 in	24 in	789 lbs
	915 mm	915 mm	305 mm	610 mm	359 kg



The following procedure is recommended for the construction of segmental retaining walls over 1.0m (3.0ft) in height, or as required by local building codes.

Clear Plan

- Aboveground Site Assessment: existing grades, structures, utilities, property lines, visible water features, etc., established.
- Contact all utility companies to confirm location of underground utilities that may not be visible in aboveground assessment.
- Proposed site modifications defined by designer (landscape architect, engineer, architect) based on owner's requirements and site limitations. Includes proposed grades, retaining wall geometry, slopes, proposed use of land (parking areas, water detention, landscape), relocation of existing structures/utilities, new structures/utilities, location of trees, etc.
- Project drawings generated and submitted to appropriate agencies for approval.
- Investigate local building codes and apply for all permits required.

Assessment of Subsurface Conditions

- Geotechnical Investigation conducted to evaluate subsurface conditions of site, including soil types, characteristic properties, in-situ state, groundwater conditions, overall slope stability, bearing capacity.
- Recommended design parameters, construction/excavation techniques, effects of proposed and existing structures, ground improvements, erosion protection, drainage considerations, anticipated settlement, etc., should be identified.

Site-Specific Retaining Wall Design

- Information provided in plan and geotechnical investigation provided to the wall design engineer.
- The design may be provided by Risi Stone Systems through the Design Assistance Program (contact local manufacturer for details), or a third-party engineer qualified in this field. The design must synthesize all available information and include cross-section and/or elevation-view drawings, specifications, calculations, quantities, and related construction details.

Pre-Construction Meeting

- We recommend that all involved parties (designers, owner's representative, general contractor, installer, inspecting engineer, supplier, etc.) attend a pre-construction meeting to define schedule and clearly state responsibilities.
- Parties not directly involved with the design and construction of the wall, but who may do future work that could influence the wall (e.g. paving, installing fences) should attend the meeting to understand the limitations of the wall and address precautions.

- Experience has shown that this simple step prevents a multitude of potential problems!

Geotechnical Inspection & General Review

- RisiStone recommends and most building codes require that a qualified engineer be retained to provide geotechnical inspection and general review of the SRW construction. These two functions can be conducted by the same individual, or a General Review Engineer may rely on the inspection and test reports of a third-party geotechnical engineer. (Refer to Specifications for details on scope and responsibilities).

Proper Installation

- Adherence to design, specifications, details, guides, and good construction practice is necessary.
- Water is controlled and managed before, during, and after construction.
- Conducted under the supervision of the General Review Engineer.

Final Grading

- Final grading should be conducted as soon as possible following construction to divert water away from the wall and create the optimum condition for great performance.

Letter of General Conformance

- General review engineer provides a letter to the owner that the wall has been constructed in general conformity with the design and specifications.

Safety Notes

- Ensure all workers are well-versed in the proper use of all equipment and vehicles
- Prior to each use, inspect all machinery to ensure that it is in good condition
- Do not exceed the recommended load/speed/capacity specified by the equipment manufacturer
- Ensure that overall maintenance of all machinery is kept up
- Follow all occupational health & safety guidelines set forth by your local government

It is critical that the contractor read and understand the wall design and specification prior to undertaking the work.



understanding the design

Depending on the stage in the design process, there are generally three potential types of design:

Typical Design

Non-site-specific design(s) selected from Risi Stone Systems' library of assumed-conditions engineered cross-section drawings (all available at risistone.com). Selected based on preliminary information regarding proposed maximum wall height, use of structure, grading, etc. Suitable for preliminary cost estimates, feasibility studies, and conceptual approvals. Typical Designs should not be used for construction.

Preliminary Design

A site-specific design produced for preliminary purposes when some details of the required design information is not yet available. Includes all elements needed to construct the wall, but is not considered ready for construction as it remains contingent on verification of some site-specific detail(s). Includes site-specific cross-section drawings, elevation views, specifications, quantity calculations, details, statement of limitations, etc. Preliminary Designs should not be used for construction.

Final Design

All necessary information has been established and the design has been deemed ready for construction. A Final Design can be sealed by an engineer.

components of the design

The design should clearly provide all information necessary to construct the proposed SRW structure. The basic components are as follows:

Design Notes / Limitations

The design should include information regarding the design standard used, limitations of design, status of design (preliminary or final), design parameters and their source, design assumptions, purpose of the wall, and potential construction issues. The design should also highlight any further review that is required by other parties.

Cross-Section Drawing(s)

The cross-section drawing is usually provided to illustrate the general arrangement of the wall, soil zones, assumed parameters, structural elements, water levels, etc. A cross-section drawing is normally provided for the maximum height section through the wall and/or the most critical section. Additional cross-sections may be provided to indicate variable conditions or wall orientation (terraces/location of structures) throughout.

Elevation-View Drawing(s)

The elevation view or profile view of the wall depicts the wall as a whole, straightening corners and curves, essentially laying the wall out flat on the page. This drawing details the overall geometry of the proposed wall, steps at the top and bottom of wall, required geogrid length and placement (where applicable), location of other structures, etc. This drawing provides the contractor with an exact model upon which to establish grades and construct the wall.

Calculations and Quantity Estimates

Risi Stone Systems conducts analysis using several sophisticated design software applications. One application routinely used is the RisiWall design software (available at risiwall.com), a state-of-the-art SRW design program with over a decade of research and development built into it. Risi Stone Systems' design reports typically feature the RisiWall design output. The detailed results of the analysis (design calculations, all design parameters, quantity calculations, etc.) may be included in the design report depending on the project requirements. The quantity calculations exactly represent the wall layout provided in the elevation view and Calculated Panel Geometry section of the RisiWall output. The contractor is responsible for verifying the quantities provided by checking the most recent grading information, and/or site grading, against the elevation view provided.

Details

The cross-section and elevation-view drawings are to be used in conjunction with the related detail drawings. These may include handrails, corners, curves, stepping foundation, steps, etc. Adherence to these details is vital for optimum wall performance.

Specifications

The Design should include standard specifications that outline specific requirements of the Design, Construction, and Materials.



Installation

- single-depth conventional installation procedure 12
- single crib installation procedure 15
- double crib installation procedure 18
- reinforced installation procedure..... 20
- alternate backfill materials 23
- vertical walls 24





single-depth installation procedure

The following are the basic steps involved in constructing a conventional single depth (non-geogrid reinforced) DuraHold segmental retaining wall. These steps are to be used in conjunction with all relevant details provided following this section.

plan

With your final design in hand, begin to establish the wall location and proposed grades. Locate all utilities and contact local utility companies before digging. Mark a line where the front of the wall will be placed, keeping in mind the 36mm (1.5in) set-back per course.

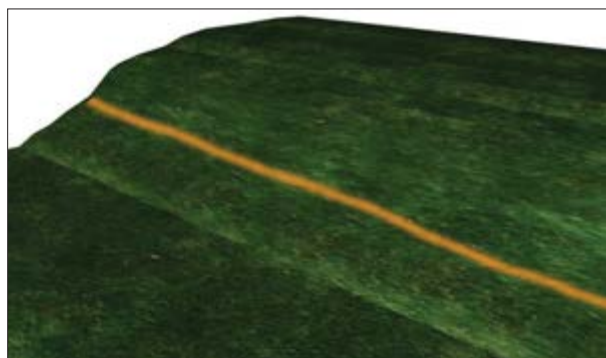

excavate

Excavate a trench down to the foundation grades specified in the design. The front of the trench should be 305mm (12in) from the planned face of the wall. The trench should be a minimum of 1525mm (60in) wide (front to back) and 610mm (24in) deep. This depth assumes one unit is buried (unit height of 305mm [12in]) plus the compacted granular base minimum depth of 305mm (12in). As the wall height increases, depth of embedment also increases, normally about 10% of the wall height. Greater embedment depths may be required to account for slopes more than 3H:1V in front of the wall, scour protection in water applications, global stability, or as specified in the design. The rear 305mm (12in) of the trench is excavated to account for the drainage layer. Excavations should be conducted in accordance with local codes under direction of the General Review Engineer (GRE).

verify foundation subgrade

Once the foundation trench has been excavated to the specified elevations, the native foundation soil must be checked by the GRE. The foundation soil must have the required allowable bearing capacity specified in the design.

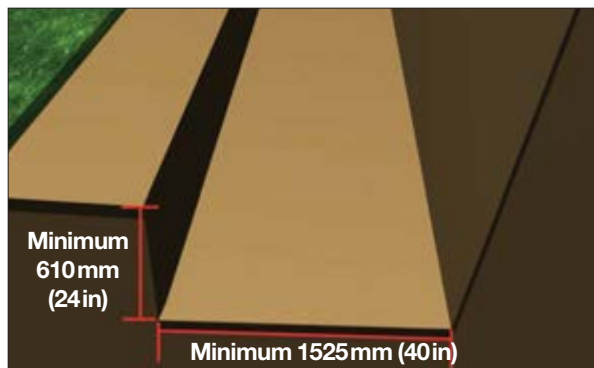

prepare the granular base

Start the base at the lowest elevation of the wall and compact to a minimum of 98% SPD. The minimum base thickness is 305mm (12in) or as required by the GRE to reach competent founding soil.

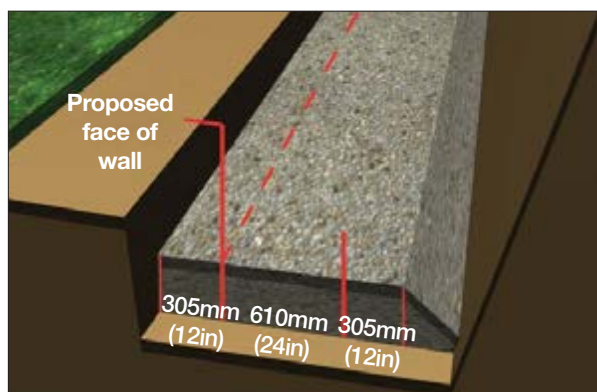

A layer of unreinforced concrete (50mm [2in] thick) may be placed on top of the of the granular material to provide a durable levelling surface for the base course. At the direction of the GRE, geotextile might be required under the granular base. The minimum base dimensions at the top are 1220mm (48in) wide (front to back) and 305mm (12in) deep. The additional 305mm (12in) trench width allows for the placement of the drain.

step the base

When the grade in front of the wall slopes up or down, the base must be stepped to compensate. Therefore, as the wall steps up in elevation, the foundation steps must be located to ensure the minimum embedment is achieved. The height of each step is 305mm (12in) – the height of one course. The 36mm (1.5in) offset must be accounted for at each step. Refer to “Stack Units” for an illustration of stepping the base.

place filter cloth

Lay the approved filter fabric (geotextile) along the bottom of the rear of the trench and extend up the exposed excavation to the proposed wall height. Leave adequate material at the top to fold back towards the wall (completely containing the drainage material). Stake the filter cloth against the slope during construction.

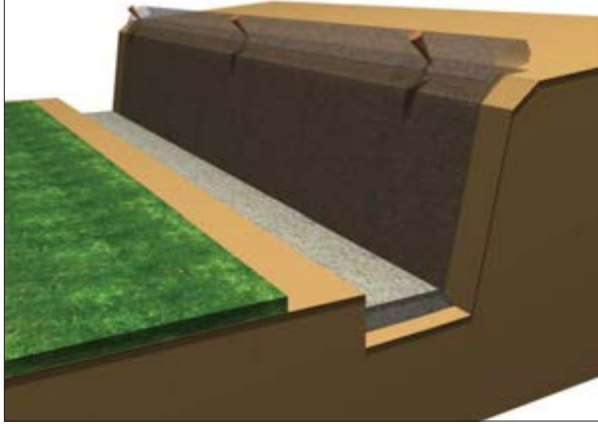

place the drain

Various options for drain placement may exist, depending on how the pipe is to be outlet (refer to *Details – Drainage*). The drain may be outlet through the wall face or connected to a drainage outlet (storm drain).

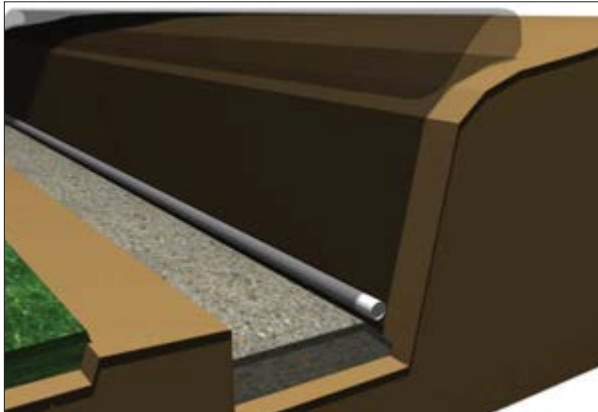

The drainage system is extremely important and outlets must be planned prior to construction. In the case of connecting to a drainage outlet, the drain should be placed at the lowest possible elevation and sloped at a minimum of 2%. At the rear of the base, allow the granular material to slope down on the sides towards the drain trench. In the 305mm (12 in) area behind the base, place the approved drain tile (perforated drain with non-woven geotextile sock) on top of the filter cloth and minimal granular coverage.

place the first course

Position a level string to mark location of the back of the first course (should be 610mm [24 in] from the proposed wall face or 915mm [36 in] from the front of the granular base). Place the

first course of DuraHold units side-by-side (touching) on the granular base.

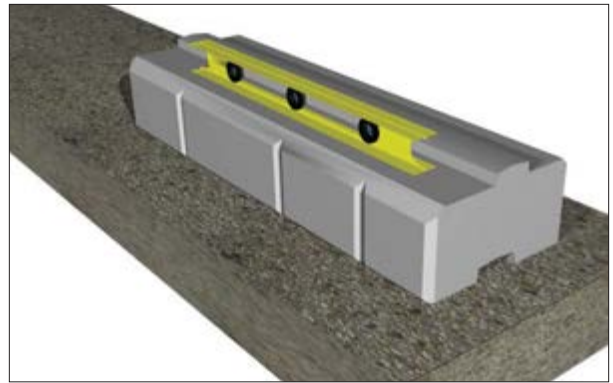
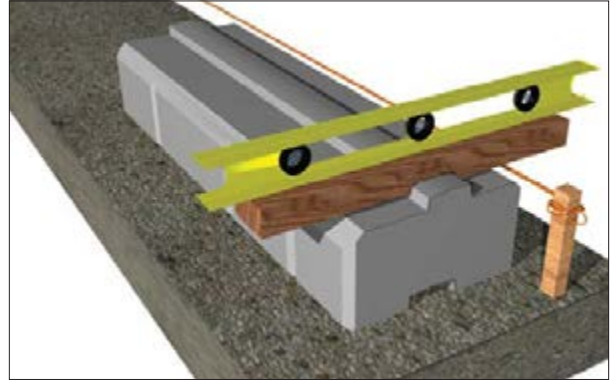

Ensure units are level front to back and left to right. Extra care should be taken at this stage as it is critical for accurate alignment.

stack units

Sweep top of underlying course. Place next course so that the end of each unit aligns with the middle of the unit below (as shown on following page), thus creating the required running bond pattern. [Note: When certain details (such as corners and curves) are incorporated into the wall, the running bond pattern may shift slightly. A small deviation of up to one quarter of the unit length from the perfect running bond pattern is allowable. However, this deviation should be corrected as soon as the wall layout allows.] Continue stacking courses to a maximum of four courses (915mm [36 in]) before backfilling.



drainage fill

Drainage fill is placed immediately behind the wall facing and compact. The drainage layer must be a minimum of 300mm (12in) thick and protected from the native material by the filter cloth.

continue stacking and filling

Continue stacking units and filling as described in the previous two steps until the desired height is reached, based on the design.



encapsulate and finish grading

Fold the excess filter fabric over the top of the drainage layer and extend up the back face of the coping unit. Ideally, place an impervious layer of soil on top of the filter fabric and compact, providing for the required grading and/or swales. For other treatments such as pavers, concrete, or asphalt, care must be taken to ensure that heavy compaction/paving equipment remains a minimum of 1.0m (3.0 ft) from the back of the coping unit. Slope the surface above and below the wall to ensure water will flow away from and not accumulate near the wall units. See the *DuraHold – Finishing Details* section for ideas on tapering down and ending the wall.





single crib installation procedure

The following are the basic steps involved in constructing a single crib DuraHold segmental retaining wall. These steps are to be used in conjunction with all relevant details provided following this section.

plan

With your final design in hand, begin to establish the wall location and proposed grades. Locate all utilities and contact local utility companies before digging. Mark a line where the front of the wall will be placed, keeping in mind the 36mm (1.5in) setback per course.

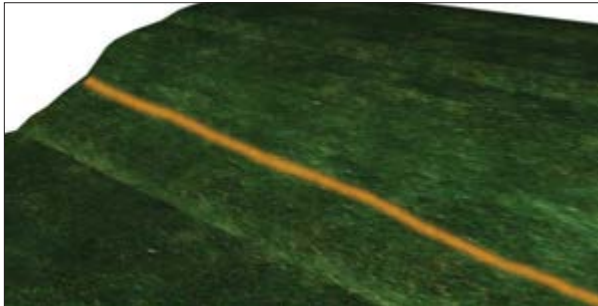

excavate

Excavate a trench down to the foundation grades specified in the design. The front of the trench should be 305mm (12in) from the planned face of the wall. The trench should be a minimum of 2745mm (108in) wide (front to back) and 610mm (24in) deep. This depth assumes one unit is buried (unit height of 305mm [12in]) plus the compacted granular base minimum depth of 305mm (12in). As the wall height increases, depth of embedment also increases, normally about 10% of the wall height. Greater embedment depths may be required to account for slopes more than 3H:1V in front of the wall, scour protection in water applications, global stability, or as specified in the design. The rear 305mm (12in) of the trench is excavated to account for the drainage layer. Excavations should be conducted in accordance with local codes under direction of the GRE.

verify foundation subgrade

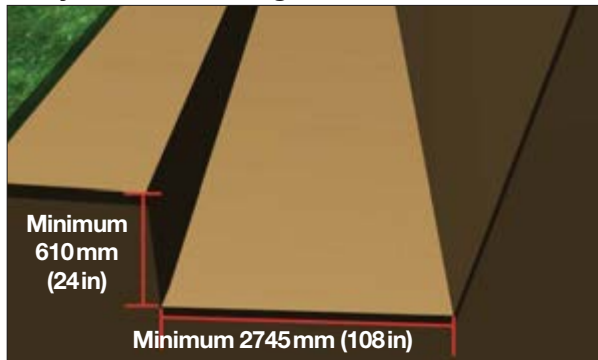

Once the foundation trench has been excavated to the specified elevations, the native foundation soil must be checked by the GRE. The foundation soil must have the required allowable bearing capacity specified in the design.

prepare the granular base

Start the base at the lowest elevation of the wall and compact to a minimum of 98% SPD. The minimum base thickness is 305mm (12in) or as required by the GRE to reach competent founding soil.

A layer of unreinforced concrete (50mm [2in] thick) may be placed on top of the of the granular material to provide a durable levelling surface for the base course. At the direction of the GRE, geotextile might be required under the granular base. The minimum base dimensions at the top are 2440mm (96in) wide (front to back) and 305mm (12in) deep. The additional 305mm (12in) trench width allows for the placement of the drain.

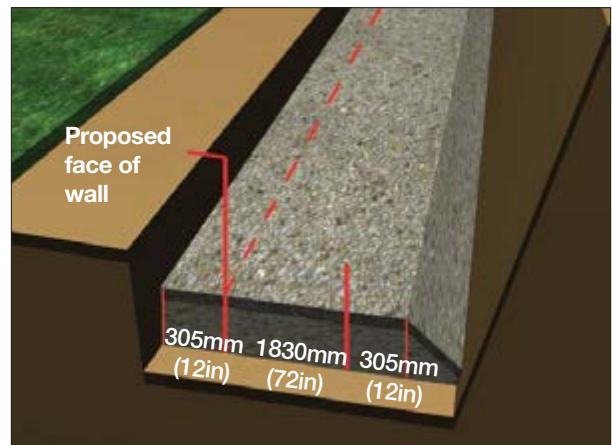

step the base

When the grade in front of the wall slopes up or down, the base must be stepped to compensate. Therefore, as the wall steps up in elevation, the foundation steps must be located to ensure the minimum embedment is achieved. The height of each step is 305mm (12in) – the height of one course. The 36mm (1.5in) offset must be accounted for at each step.

place filter cloth

Lay the approved filter fabric (geotextile) along the bottom of the rear of the trench and extend up the exposed excavation to the proposed wall height. Leave adequate material at the top to fold back towards the wall (completely containing the drainage material). Stake the filter cloth against the slope during construction.

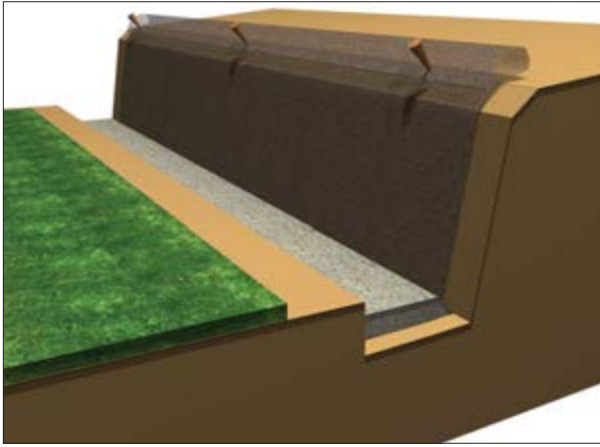

place the drain

Various options for drain placement may exist, depending on how the pipe is to be outlet (refer to *DuraHold – Drainage*). The drain may be outlet through the wall face or connected to a drainage outlet (storm drain).

The drainage system is extremely important and outlets must be planned prior to construction. In the case of connecting to a drainage outlet, the drain should be placed at the lowest possible elevation and sloped at a minimum of 2%. At the rear of the base, allow the granular material to slope down on the sides towards the drain trench. In the 305mm (12in) area behind the base, place the approved drain tile (perforated drain with non-woven geotextile sock) on top of the filter cloth and minimal granular coverage.

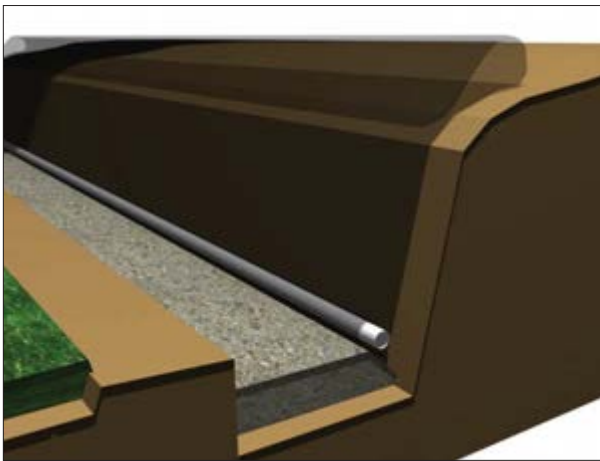

place the first course

Position a level string to mark the location of the back of the first course (should be 1830mm [72in] from the proposed wall face or 2135mm [84in] from the front of the granular base). Place the first course of DuraHold Standard and Tieback units side-by-side (alternating as shown) on the granular base. Ensure units are level front to back and left to right. Extra care should be taken at this stage as it is critical for accurate alignment.

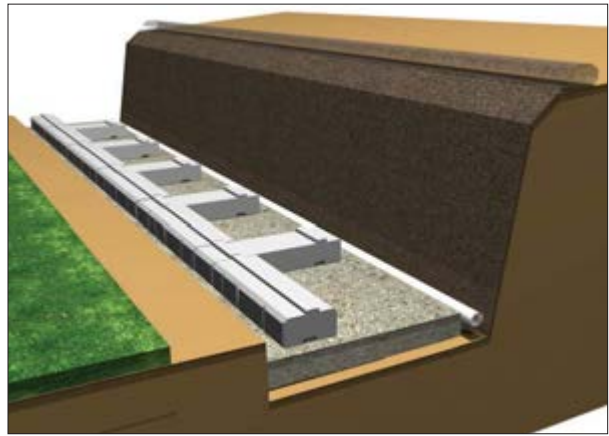

Once the first course is installed, the crib fill material is to be placed and compacted to 95% SPD. The crib fill material must be raised so the deadmen (standard units) can be placed on a level surface (i.e. the top of the fill must be at the same elevation as the top of the DuraHold tieback unit). The crib fill also functions as the drainage fill material.

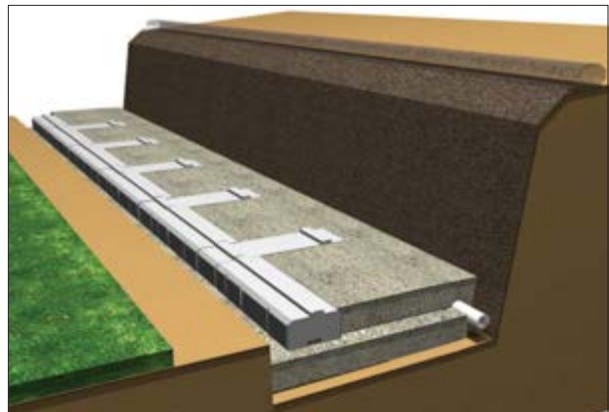

Place the next course of standard units along the face. Deadman must be placed on every tieback and centred.

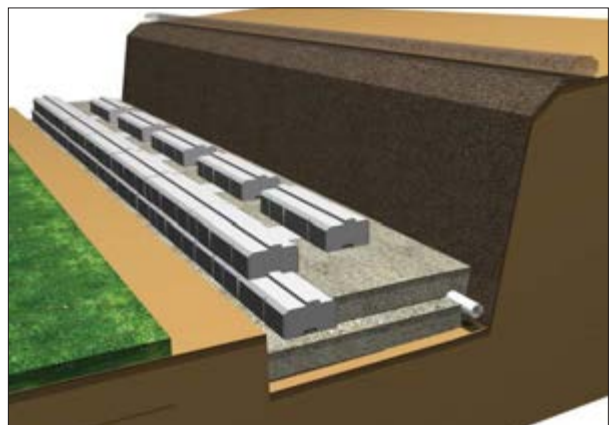

Place and compact fill to 95% SPD. The fill must be raised so the tiebacks can be placed on a level surface with the course below.

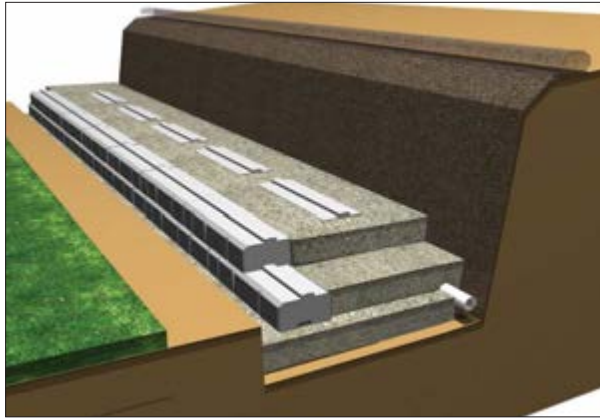

Place the next course of standard units and tiebacks on the wall. The tiebacks are to be placed on the centre of each deadman.



Continue to construct the crib wall until the required height in the design is reached (dependent on site conditions such as loading, soil, etc.). The top portion of the wall may be constructed as a conventional gravity structure as shown in the previous section.

drainage fill

Drainage fill is placed immediately behind the wall facing and compact. The drainage layer must be a minimum of 300mm (12in) thick and protected from the native material by the filter cloth.

encapsulate and finish grading

Fold the excess filter fabric over the top of the drainage layer and extend up the back face of the coping unit. Ideally, place an impervious layer of soil on top of the filter fabric and compact, providing for the required grading and/or swales. For other treatments such as pavers, concrete, or asphalt, care must be taken to ensure that heavy compaction/paving equipment remains a minimum of 1.0m (3.0 ft) from the back of the coping unit. Slope the surface above and below the wall to ensure water will flow away from and not accumulate near the wall units. See the *Finishing Details* section for ideas on tapering down and ending the wall.





double crib installation procedure

The following are the basic steps involved in constructing a double crib DuraHold segmental retaining wall. These steps are to be used in conjunction with all relevant details provided following this section.

plan

With your final design in hand, begin to establish the wall location and proposed grades. Locate all utilities and contact local utility companies before digging. Mark a line where the front of the wall will be placed, keeping in mind the 36mm (1.5in) set-back per course.

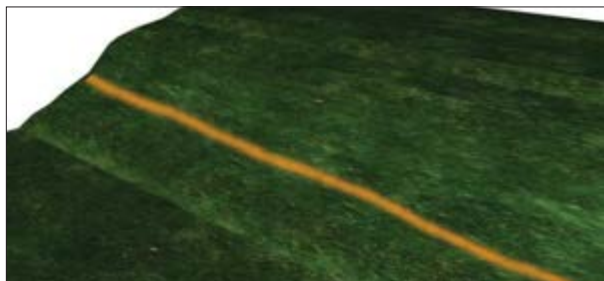

excavate

Excavate a trench down to the foundation grades specified in the design. The front of the trench should be 305mm (12in) from the planned face of the wall. The trench should be a minimum of 3965mm (156in) wide (front to back) and 610mm (24in) deep. This depth assumes one unit is buried (unit height of 305mm [12in]) plus the compacted granular base minimum depth of 305mm (12in). As the wall height increases, depth of embedment also increases, normally about 10% of the wall height. Greater embedment depths may be required to account for slopes more than 3H:1V in front of the wall, scour protection in water applications, global stability, or as specified in the design. The rear 305mm (12in) of the trench is excavated to account for the drainage layer. Excavations should be conducted in accordance with local codes under direction of the General Review Engineer (GRE).

verify foundation subgrade

Once the foundation trench has been excavated to the specified elevations, the native foundation soil must be checked by the

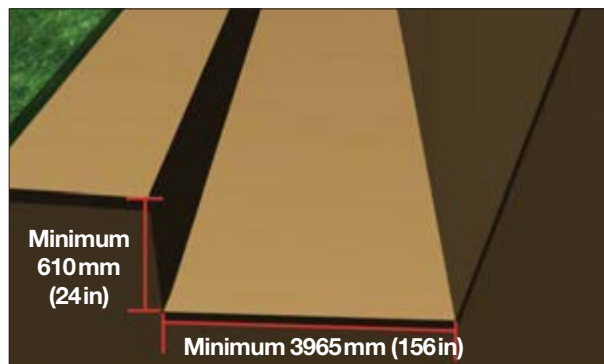

GRE. The foundation soil must have the required allowable bearing capacity specified in the design.

prepare the granular base

Start the base at the lowest elevation of the wall and compact to a minimum of 98% SPD. The minimum base thickness is 305mm (12in) or as required by the GRE to reach competent founding soil. A layer of unreinforced concrete (50mm [2in] thick) may be placed on top of the granular material to provide a durable levelling surface for the base course. At the direction of the GRE, geotextile might be required under the granular base. The minimum base dimensions at the top are 3660mm (144in) wide (front to back) and 305mm (12in) deep. The additional 305mm (12in) trench width allows for the placement of the drain.

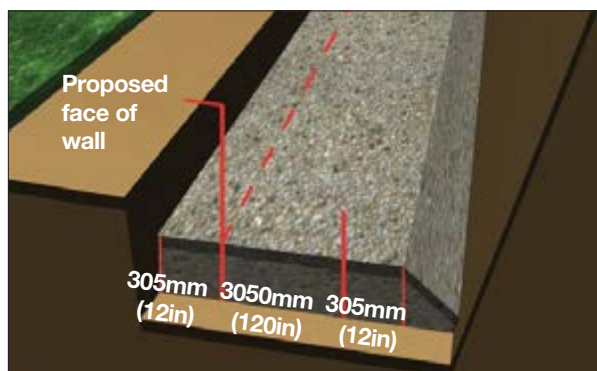

step the base

When the grade in front of the wall slopes up or down, the base must be stepped to compensate. Therefore, as the wall steps up in elevation, the foundation steps must be located to ensure the minimum embedment is achieved. The height of each step is 305mm (12in) – the height of one course. The 36mm (1.5in) offset must be accounted for at each step.

place filter cloth

Lay the approved filter fabric (geotextile) along the bottom of the rear of the trench and extend up the exposed excavation to the proposed wall height. Leave adequate material at the top to fold back towards the wall (completely containing the drainage material). Stake the filter cloth against the slope during construction.

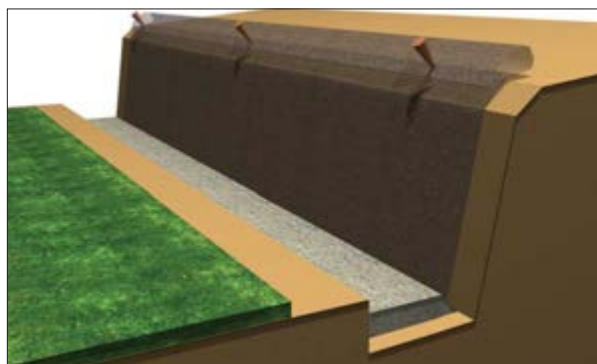

place the drain

Various options for drain placement may exist, depending on how the pipe is to be outlet (refer to *DuraHold – Drainage*). The drain may be outlet through the wall face or connected to a drainage outlet (storm drain). The drainage system is extremely important and outlets must be planned prior to construction. In the case of connecting to a drainage outlet, the drain should be placed at the lowest possible elevation and sloped at a minimum of 2%. At the rear of the base, allow the granular material to slope down on the sides towards the drain trench. In the 305mm (12 in) area behind the base, place the approved drain tile (perforated drain with non-woven geotextile sock) on top of the filter cloth and minimal granular coverage.

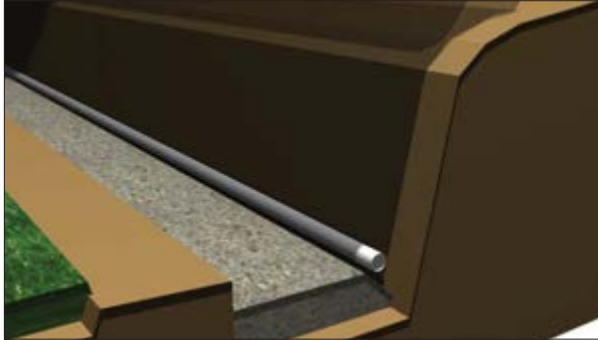

place the first course

Position a level string to mark the location of the back of the first course (should be 3050mm [120 in] from the proposed wall face or 3355 mm [132 in] from the front of the granular base). Commence construction of double crib by alternating standard units and tiebacks, as described in construction of single crib. Place deadmen (standard units) so that there is a 0.6m (2ft) gap between tieback and deadman, while ensuring deadmen are centered on their respective tieback (as shown). Ensure units are level front to back and left to right. Extra care should be taken at this stage as it is critical for accurate alignment.

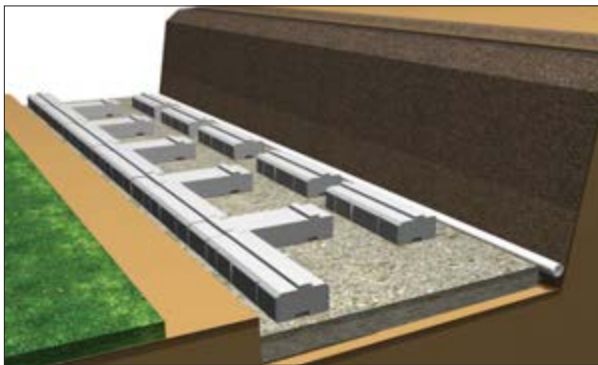

Place and compact crib fill to 95% SPD. Crib fill should be compacted in lifts to a height equivalent to that of a DuraHold unit (305mm [12in]) to create a level surface upon which the additional tieback can be placed. The crib fill also functions as the drainage fill material. Construct second course by placing standard units and additional tieback units as shown. Tieback units are to be positioned such that its grooves engage both the tieback and deadmen tongues on the lower course.

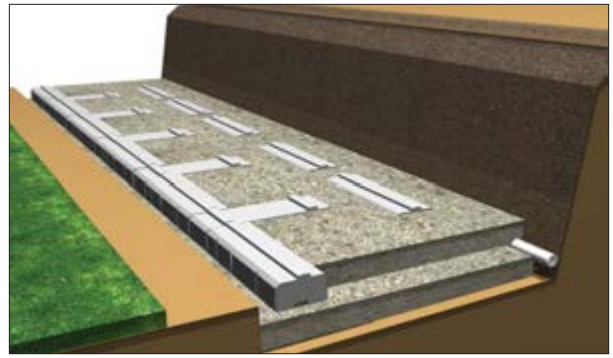

Place and compact crib fill (to 95% SPD) around standard units and tiebacks in order to create a level starting surface to repeat the above steps until the desired double crib height is achieved. Once completed, continue construction by following instructions on how to install a single crib, and then a conventional wall.

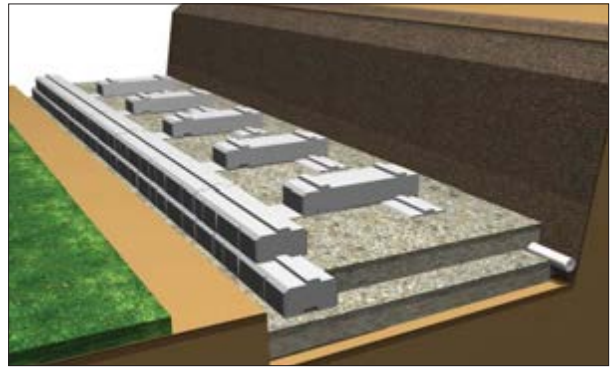

encapsulate and finish grading

Fold the excess filter fabric over the top of the drainage layer and extend up the back face of the coping unit. Ideally, place an impervious layer of soil on top of the filter fabric and compact manually, providing for the required grading and/or swales. For other treatments such as pavers, concrete, or asphalt, care must be taken to ensure that heavy compaction/paving equipment remains a minimum of 1.0m (3.0 ft) from the back of the coping unit. Slope the surface above and below the wall to ensure water will flow away from and not accumulate near the wall units. See the *DuraHold – Finishing Details* section for ideas on tapering down and ending the wall.

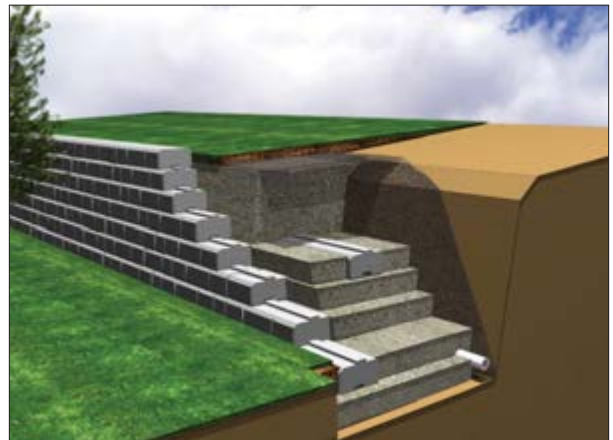



reinforced srw installation procedure

The following procedure outlines the installation of a geogrid-reinforced wall using imported, well-draining gravel as the reinforced fill. For use of on-site soils as the reinforced fill, refer to *Alternate Reinforced Fill Materials*.

plan

Before beginning construction, be sure to have a final design and arrangements made for a General Review Engineer (GRE) to be present. Begin to establish the wall location and proposed grades. Locate all utilities and contact local utility companies before digging. Mark a line where the front of the wall will be placed, keeping in mind the 36mm (1.5 in) setback per course.

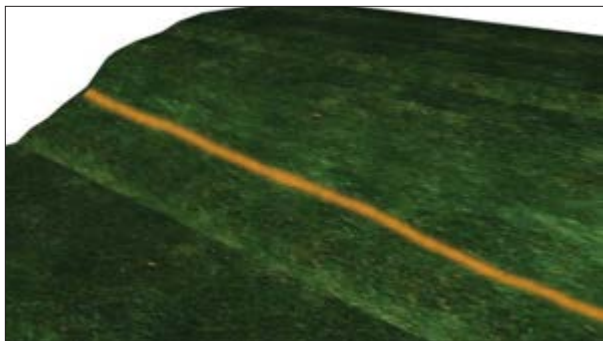

excavate reinforced zone

The excavation must be carefully planned and consider several elements. Based on the type of soil being excavated, the GRE must determine the maximum allowable “cut” angle the excavation can sustain. This angle ensures the stability of the excavation during construction. The required geogrid length (as shown in the design) plus 305mm (12 in) defines the minimum width at the base of the excavation. Measuring from 305mm (12 in) in front of the wall face, extend a line back a distance equal to the base width determined above. Before excavating, consider structures and trees that may be impacted by the excavated slope. Excavation continues until the slope is cleared and a flat area at the base is exposed extending 305mm (12 in) past the proposed face of the wall.

excavate granular base

Excavate a trench for the granular base. The front of the trench should be 305mm (12 in) from the planned face of the wall. The trench should be a minimum of 1525mm (60 in) wide (front to back) and 610mm (24 in) deep. This depth assumes one unit is buried (unit height of 305mm [12 in]) plus the compacted granular base minimum depth of 305mm (12 in). As wall height increases, depth of embedment also increases, normally about 10% of the wall height. Greater embedment depths may be required to account for slopes more than 3H:1V in front of the wall, scour protection in water applications, global stability, or as specified

in the design. The rear 305mm (12 in) of the trench is excavated to account for the drain.

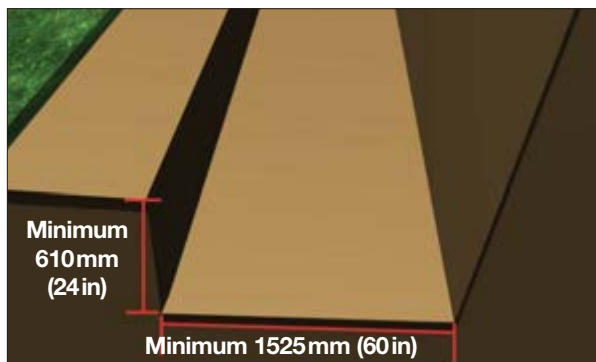

verify foundation subgrade

Once the wall has been excavated, the native foundation soil must be checked by the GRE. The foundation soil in a geogrid-reinforced SRW is considered to be the material underneath both the facing and reinforced zone; that is, the entire wall footprint. This verification should not just be limited to the soil underneath the granular footing. The foundation soil must have the required allowable bearing capacity specified in the design.

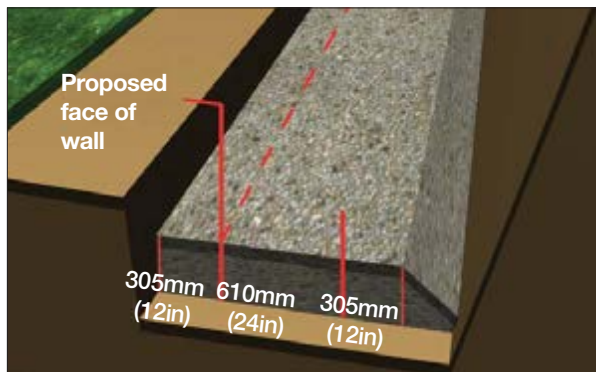

prepare the granular base

The base should be started at the lowest elevation of the wall and be compacted to a minimum of 98% SPD. The minimum base thickness is 305mm (12 in) or as required by the GRE. A layer of unreinforced concrete (50mm [2 in] thickness) may be placed on top of the of the granular material to provide a durable level surface for the base course. The minimum base dimensions are 1220mm (48 in) wide (front to back) and 305mm (12 in) deep. The additional 305mm (12 in) trench width allows for the placement of the drain.

step the base

When the grade in front of the wall slopes up or down, the base must be stepped to compensate. As the foundation steps up,

ensure the minimum embedment is maintained. The height of each step is 305mm (12 in) – the height of one course. The 36mm (1.5in) offset must be accounted for at each step. Refer to “Stack Units” for an illustration of stepping the base.

place filter cloth

Lay the approved filter fabric (geotextile) along the bottom of the rear 305mm [12in] of the excavation and extend up the exposed cut face to the proposed wall height. Leave adequate material at the top to fold back towards the wall (completely containing the reinforced fill material). Stake the filter cloth against the slope during construction.

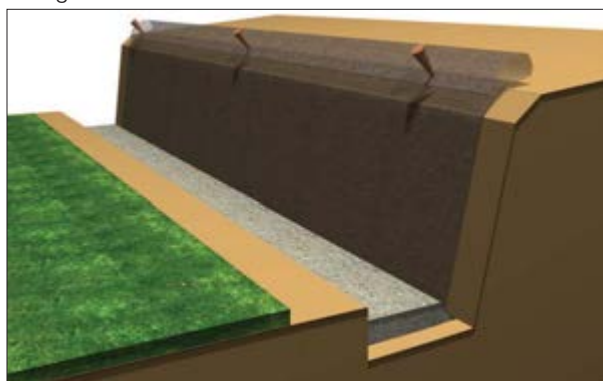

place the drain

Various options for drain placement may exist, depending on how the pipe is to be outlet (refer to *Drainage*). The drain may be outlet through the wall face or connected to a drainage outlet (storm drain). The drainage system is extremely important and outlets must be planned prior to construction.

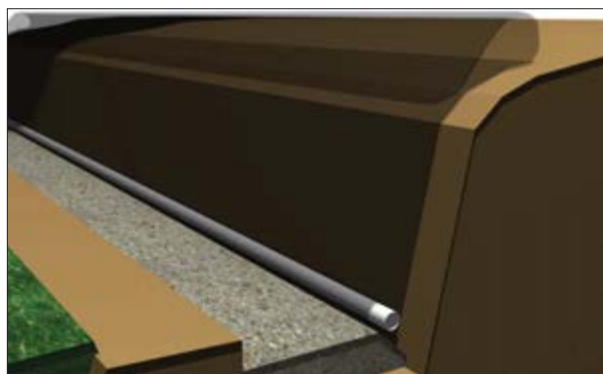

In the case of connecting to a drainage outlet, the drain should be placed at the lowest possible elevation and sloped at a minimum of 2%. At the rear of the base, allow the granular material to slope down on the sides towards the drain trench. In the 305mm (12 in) area behind the base, place the approved drain tile (perforated drain with non-woven geotextile sock) on top of the filter cloth and minimal granular coverage.

place the first course

Position a level string to mark location of first course (should be 915mm [36in] from the front edge of the granular base). Place

the first course of DuraHold units side-by-side (touching) on the granular base.

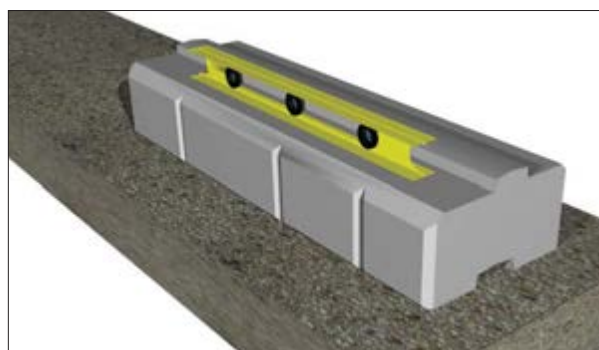

Ensure units are level front to back and left to right. Extra care should be taken at this stage as it is critical for accurate alignment.

stack units

Sweep the top of the underlying course. Place the next course so that the end of each unit aligns with the middle of the unit below (as shown on the following page), thus creating the required running bond pattern. Continue stacking courses up to the elevation of the first layer of geogrid or to a maximum of four courses (915mm [36in]) before backfilling.

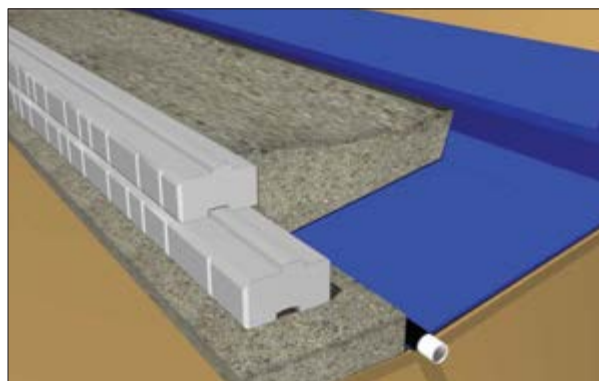

reinforced fill

Begin by placing reinforced fill behind the wall. The reinforced fill is placed in maximum 150mm–200mm (6in–8in) lift thickness and compacted to a minimum of 95% SPD. The compaction must be checked by the GRE at regular intervals.

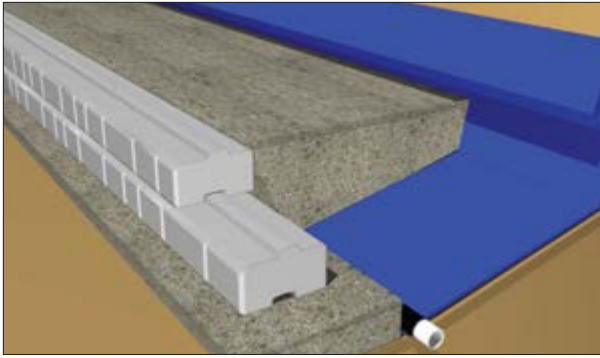

Continue backfilling up to the elevation of the first layer of geogrid reinforcement. Caution must be taken to ensure the allowable lift thickness is not exceeded and/or heavy compaction equipment is not operated within 1m of the back of the wall (only hand-operated plate compactor). Overcompaction behind the wall facing will result in an outward rotation of the units and poor vertical alignment.

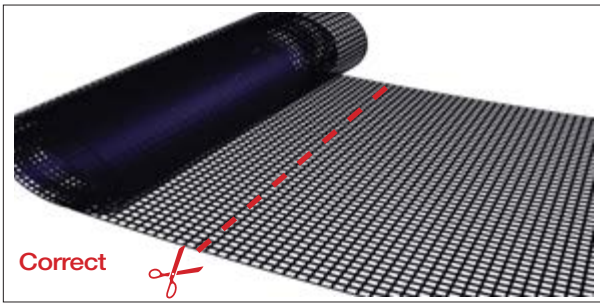

install geogrid reinforcement

Ensure the geogrid reinforcement specified in the design matches the product on site (no substitutes are acceptable without consent of the design engineer). Cut the geogrid from the roll to the specified length, ensuring the geogrid is being cut perpendicular to the direction of primary strength.

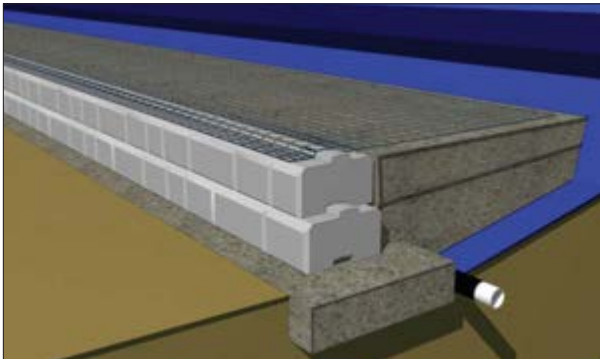

Ensuring the DuraHold units are free of debris, lay the geogrid on top of the units to within 25mm (1 in) of the face. Place the next course of DuraHold units (as described above) to secure the geogrid in place. Pull the geogrid reinforcement taut across the reinforced fill material to its full length and stake in place to maintain tension. The reinforced fill material should be level with the back of the DuraHold unit, allowing the geogrid to be laid out horizontally.

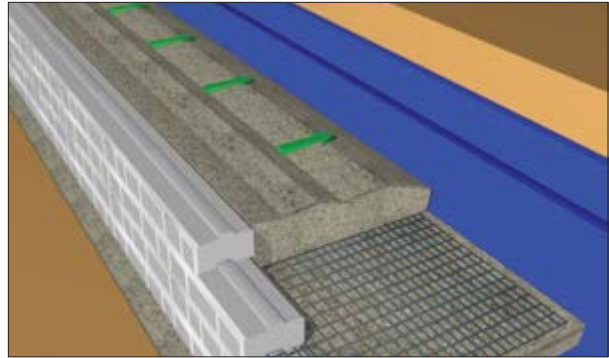

place fill over geogrid reinforcement

Place next lift of fill material on top of the geogrid reinforcement, placing the loose material at the front of the wall, and raking it back, away from the face (this method maintains tension in the geogrid during filling). Continue stacking units and filling until the next layer of geogrid reinforcement is reached. Continue placing the DuraHold units, filling, and laying the geogrid reinforcement as described above until the desired wall height is reached.

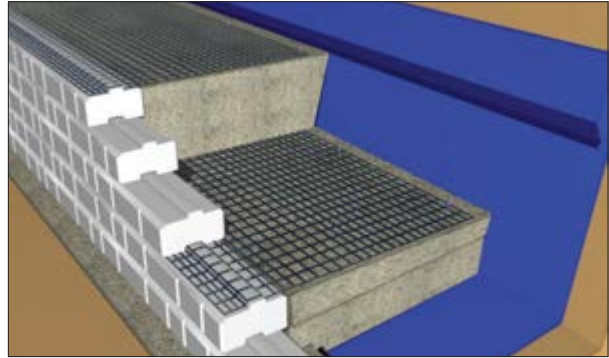

encapsulate and finish grading

Fold the excess filter fabric over the top of the fill (reinforced zone) and extend up the back face of the coping unit. Ideally, place an impervious layer of soil on top of the filter fabric and compact, providing for the required grading and/or swales. For other treatments such as pavers, concrete, or asphalt, care must be taken to ensure that heavy compaction/paving equipment remains a minimum of 1.0m from the back of the coping unit. Slope the surface above and below the wall to ensure water will flow away from and not accumulate near the wall units.

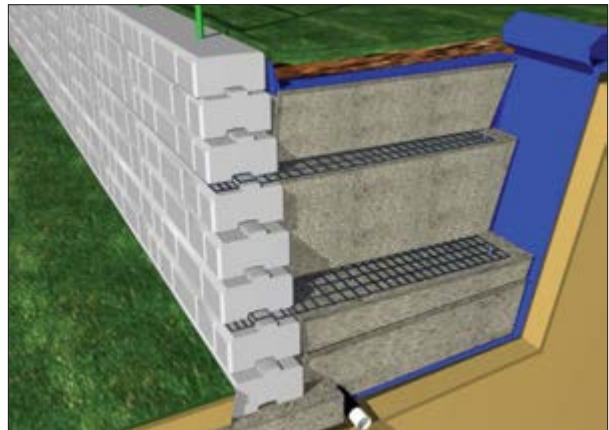



alternate reinforced fill materials

In the geogrid installation, we recommend using well-graded, free-draining (maximum 8% fines) granular fill material for the reinforced zone. This type of high quality material has several important benefits:

benefits of imported granular (free-draining) material

- Does not require tedious construction of drainage layer.
- Requires less monitoring by GRE.
- Compaction is less dependent on moisture content.
- Less susceptible to long-term creep of the soil mass.
- Higher shear capacity (greater strength) means less geogrid reinforcement.
- Better drainage and higher performance.

use of other approved materials

Other approved materials may be utilized for fill, subject to minimum recommended parameters. We recommend that alternative fill materials be limited to:

- Fine-grained soils with low plasticity (i.e. SC, ML, CL, with $PI \leq 20$)
- Material free of organics, debris, and with low to moderate frost heave potential that is approved by the GRE as adequate for structural fill

construction of required drainage layer when using non-free-draining materials

As these materials are not considered to be free-draining, a minimum 300mm (12in) thick, 19mm ($\frac{3}{4}$ in) clear stone drainage layer must be placed immediately behind the wall with design-specified filter cloth to separate it from the reinforced soil. At the geogrid layer elevations, the filter cloth must be cut and have minimum 150mm (6in) overlap as shown in the drawing.

The reinforced soil must be placed at maximum 200mm (8in) lift thickness and compacted to 95% SPD or as specified in the design. At subsequent geogrid layers, the drainage layer must be completely encapsulated as described above. As this is a critical component of the wall construction, care must be taken to ensure the drainage material is protected from contamination.

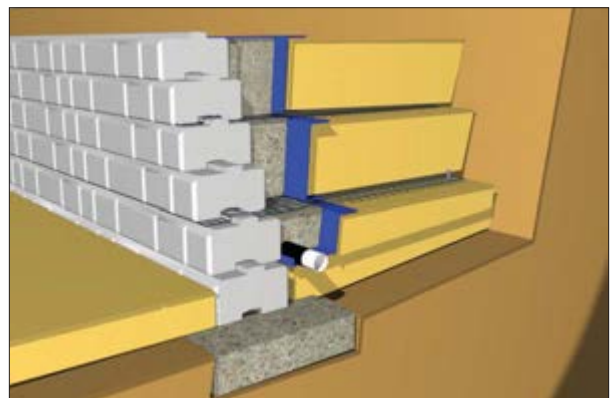
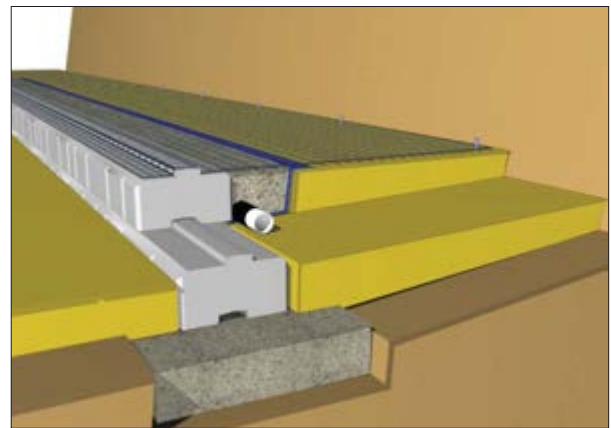
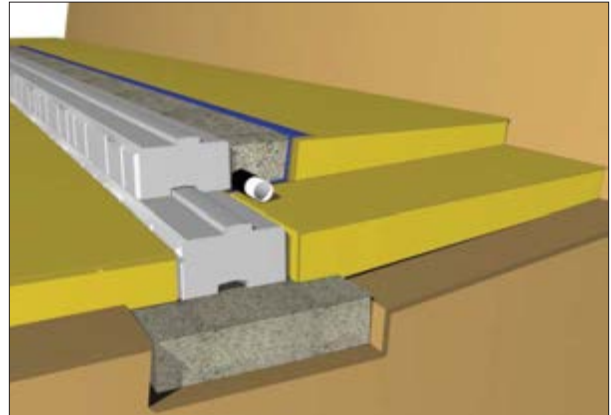



vertical walls

There are several key factors that should be considered when constructing a successful vertical wall.

- Units on every other course must be rotated 180°.
- As SRWs are designed to “relax” forward to develop an Active Earth Pressure, it is very possible that a vertical wall could rotate forward past vertical, either during or after construction. To help accommodate this rotation, it is recommended that the base be constructed with a 2% negative slope from front to back (as shown).
- The foundation material plays a substantial part in vertical walls. Any settlement in these types of walls could result in an over-vertical batter. Extra care must be taken to ensure the foundation bearing capacity is more than adequate, and that any anticipated settlement is taken into account.
- Over-compaction of the fill material behind the units may cause the SRW units to rotate forward beyond vertical. It is important to keep the compaction lifts of the fill materials to a minimum (150–200mm [6–8in]). Heavy equipment must be kept a minimum of 1m (3ft) from the back of the SRW units.

It is generally recommended that battered walls be constructed wherever possible. However, with proper preparation and care, vertical walls can be constructed successfully.





Details

- **outside corners.....26**
 - 90° outside corners 26
 - odd-angled outside corners..... 28
- **inside corners31**
 - 90° inside corners 31
 - odd-angled inside corners 33
- **curves.....37**
 - convex curves..... 37
 - concave curves 37
- **fences.....39**
 - wood fences 39
 - guardrails..... 40
 - pedestrian handrail/chainlink fence 40
- **obstructions.....41**
 - catch basins 41
 - structures..... 41
 - trees 41
- **internal drainage.....42**
- **external drainage.....44**
 - swales 44
 - blanket/chimney drains..... 44
 - water applications 44
 - structures..... 44
 - box culverts & headwalls 45
 - round culvert through wall 45
- **steps.....46**
 - inset 45
 - protruding 45
- **terraces48**
 - conventional 48
 - reinforced..... 48
- **finishing details.....49**
 - 90° return end..... 49
 - stepped down end..... 49
 - abut existing structure..... 49





90° outside corners

Single-Depth Construction

Place standard units on base course leading to the corner. Place corner unit (left corner shown) so both rough faces will be exposed in the final construction.

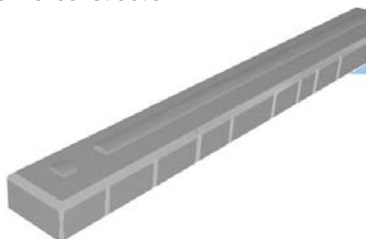

Continue placing standard units on adjacent wall, abutting the back side of the corner unit.



For a strong, tight corner, apply a concrete adhesive to the area where the corner units will overlap. Place alternate corner unit (right corner shown) to interlock corner.

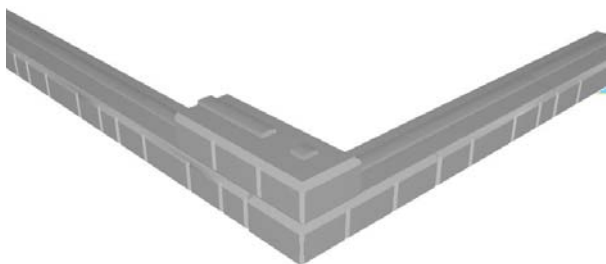

Place standard units to complete the course.

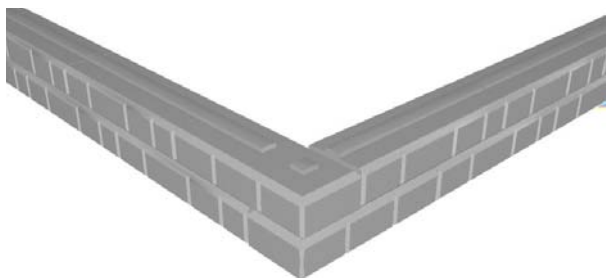

Repeat until desired wall height is achieved.

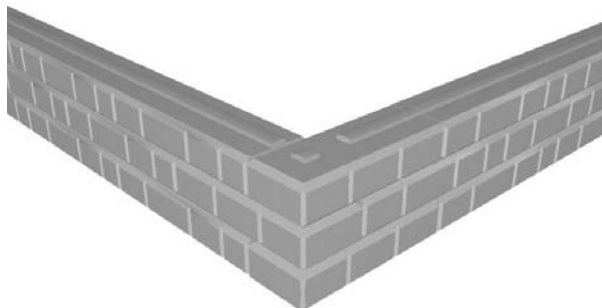

Mitre cut coping and place units as shown.

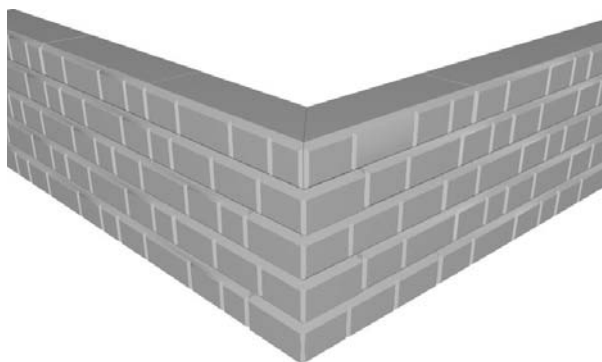

Reinforced Construction

For reinforced applications, it is better to place the layers of reinforcement on different courses, on either side of the corner, so the layers of reinforcement do not lie directly on top of each other. If the reinforcement must be placed on the same course on both sides of the corner, a minimum of 75mm (3 in) of reinforced fill must be placed and compacted between the layers of reinforcement. Also, never overlap the reinforcement in the joint between stacked SRW courses and ensure the leading edge of the reinforcement is placed within 25mm (1 in) of the face of the SRW units.

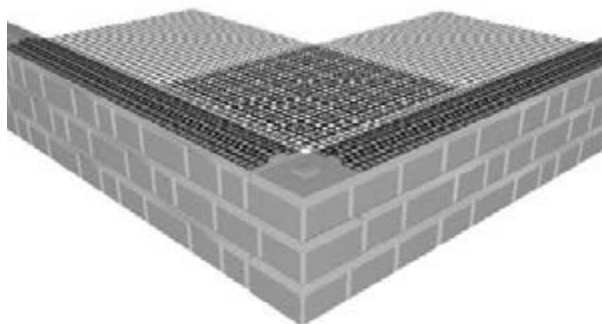

Crib Construction

NOTE: Once the recommended single crib height is achieved (refer to site-specific design), the remaining courses can be installed with standard single depth DuraHold units.

Place units on base course leading to the corner. Continue placing base course units on adjacent wall, as shown.



Commence second course by placing alternate corner unit to interlock corner. Place standard units and deadman units leading up to corner. **NOTE:** Deadman unit located closest to 90° corner may have to be adjusted slightly to allow for placement of deadman on adjacent wall. Continue placing standard units and deadman units on adjacent wall to complete course.

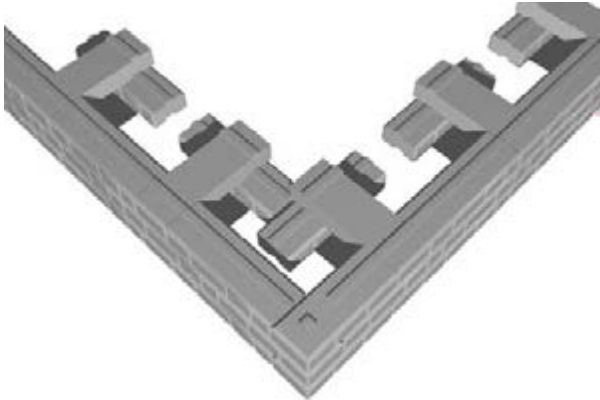

Alternate base course and second course construction techniques until desired wall height is achieved.

odd-angled outside corners

Single-Depth Construction

Place standard units on base course leading to the corner. Place modified corner unit (left corner shown) so both rough faces will be exposed in the final construction.



Continue placing standard units on adjacent wall, abutting the cut side of the modified corner unit.

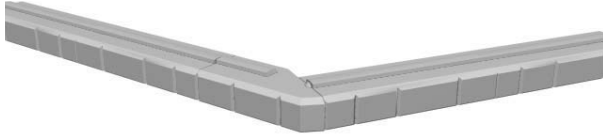

For a strong, tight corner, apply a concrete adhesive to the area where the corner units will overlap. Place alternate modified corner unit (right corner shown) to interlock corner.



Place standard units to complete the course.



Repeat until desired wall height is achieved.

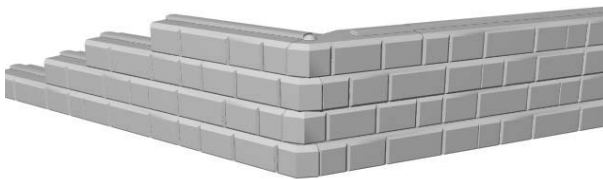

Mitre cut coping and place units as shown.

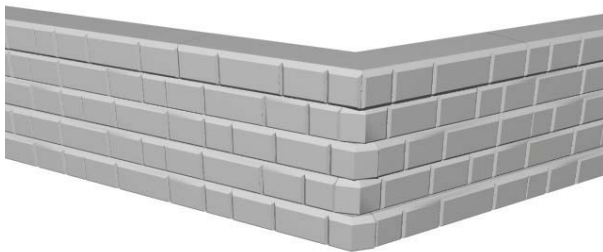

Reinforced Construction

For reinforced applications, it is better to place the layers of reinforcement on different courses, on either side of the corner, so that the layers do not lie directly on top of each other. If the

reinforcement must be placed on the same course on both sides of the corner, a minimum of 75mm (3 in) of reinforced fill must be placed and compacted between the layers of reinforcement. Also, never overlap the reinforcement in the joint between stacked SRW courses and ensure the leading edge of the reinforcement is placed within 25mm (1 in) of the face of the SRW units.



Crib Construction

Place units on base course leading to the corner. Continue placing base course units on adjacent wall as shown.

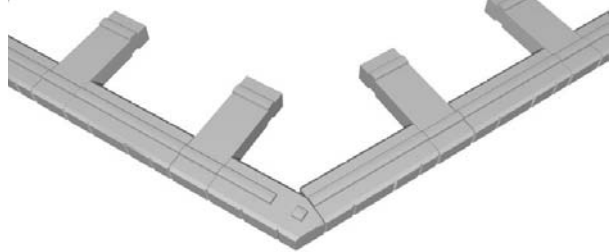

Note: For angles between 0° and 45° an additional tieback should commence adjacent wall, and half-tapered units may have to be substituted for deadmen on either side of corner – similar to construction of 45° Outside Single Crib. For angles between 45° and 90° follow construction technique as shown.

Commence second course by placing alternate corner unit to interlock corner. Place standard units and deadman units leading up to corner. **[Note:** Deadman unit located closest to corner may have to be adjusted slightly to allow for placement of deadman on adjacent wall. Continue placing standard units and deadman units on adjacent wall to complete course.]

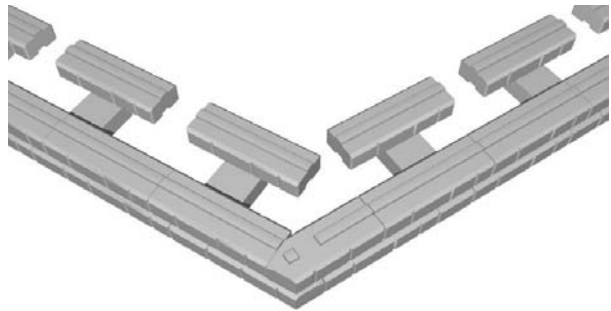

Alternate base course and second course construction techniques until desired wall height is achieved.

Making Modified Corner Units

To construct corners for any angle, other than those created using the manufactured corner units, you will need to make modified corner units as follows.

The tools you need to modify a unit include: tape measure, framing square, chalk, concrete saw, chisel and hammer.

Identify the necessary unit measurements from the table based on the angle of the corner. Decide if you are going to make a left or right modified corner unit. Select a unit identified in the "Unit to Modify" column of the table. If you are using a 90° corner unit to start with, make sure you select the left or right corner unit that corresponds to the corner unit you are making. Use the appropriate diagram when measuring for your cut and face cut lines.

Measure the distances specified, on the front and back of the unit, and mark the SRW unit.

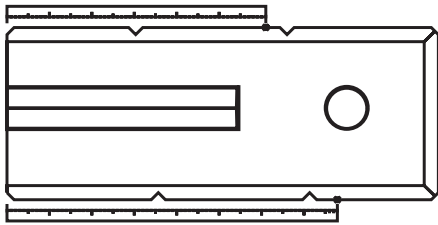

On one arm of the framing square, mark the specified cut length. On the other arm mark the specified face cut length.

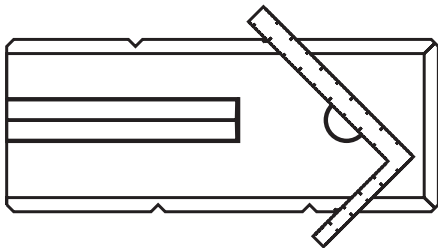

Align the marks on the framing square with the marks on the SRW unit. Trace the edge on the framing square to mark the unit. For outside corners, make sure the cut dimension is to the back of the SRW unit.

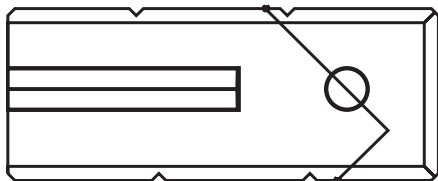

Saw cut the unit along the cut and face cut lines to create a smooth square edge that will neatly abut the side of a standard unit.

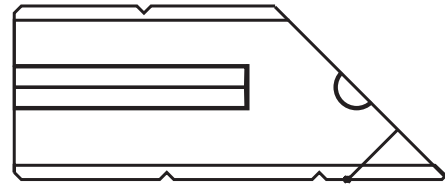

It will also be necessary to remove a portion of the key to allow the SRW unit from the next course to stack properly.

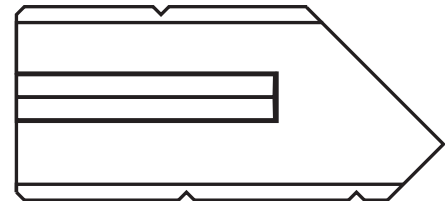
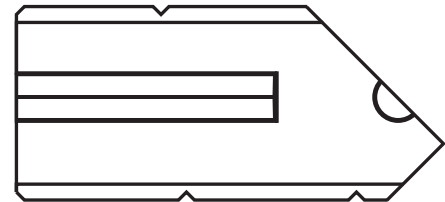

Outside Corner – Metric Dimensions

Angle [degrees]	Front [mm]	Back [mm]	Face Cut [mm]	Cut [mm]	Unit to modify
5	942	915	27	610	Standard
10	968	915	53	610	Standard
15	995	915	80	610	Standard
20	1023	915	108	610	Standard
25	1050	915	135	610	Standard
30	1078	915	163	610	Standard
35	1107	915	192	610	Standard
40	1137	915	222	610	Standard
45	Use manufactured 45° corner unit				
50	1199	915	284	610	90° corner
55	1233	915	318	610	90° corner
60	1267	915	352	610	90° corner
65	1304	915	389	610	90° corner
70	1342	915	427	610	90° corner
75	1383	915	468	610	90° corner
80	1427	915	512	610	90° corner
85	1474	915	559	610	90° corner
90	Use manufactured 90° corner unit				
91 – 180	Not Recommended				

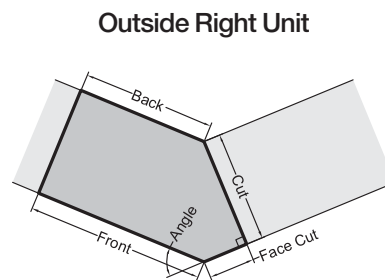
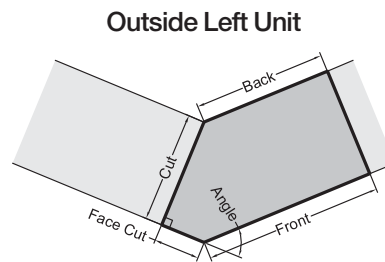

Outside Corner – Imperial Dimensions

Angle [degrees]	Front [inches]	Back [inches]	Face Cut [inches]	Cut [inches]	Unit to modify
5	37 1/8	36	1	24	Standard
10	38 1/8	36	2 1/8	24	Standard
15	39 1/8	36	3 1/8	24	Standard
20	40 1/4	36	4 1/4	24	Standard
25	41 3/8	36	5 3/8	24	Standard
30	42 1/2	36	6 3/8	24	Standard
35	43 5/8	36	7 5/8	24	Standard
40	44 3/4	36	8 3/4	24	Standard
45	Use manufactured 45° corner unit				
50	47 1/4	36	11 1/4	24	90° corner
55	48 1/2	36	12 1/2	24	90° corner
60	49 7/8	36	13 7/8	24	90° corner
65	51 3/8	36	15 1/4	24	90° corner
70	52 7/8	36	16 7/8	24	90° corner
75	54 1/2	36	18 3/8	24	90° corner
80	56 1/8	36	20 1/8	24	90° corner
85	58	36	22	24	90° corner
90	Use manufactured 90° corner unit				
91 – 180	Not Recommended				



90° inside corners

Single-Depth Construction

Place standard units on base course leading to the corner. Place 90° corner unit (left corner shown) so what remains of the original split face will be exposed in the final construction.



Continue placing standard units on adjacent wall, abutting the front side of the corner unit. It may be necessary to remove bumps from the face of the corner unit to achieve a tight fit.



For a strong, tight corner, apply a concrete adhesive to the area where the corner units will overlap. Place alternate corner unit (right corner shown) to interlock corner.

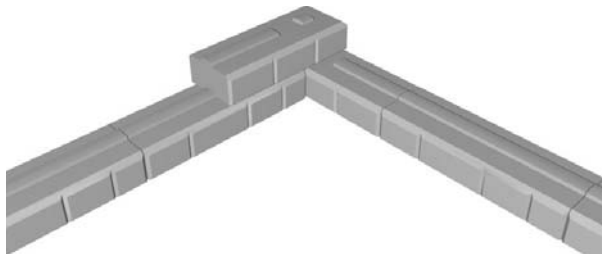

Place standard units to complete the course.



Repeat until desired wall height is achieved.



Mitre cut coping units and place as shown.

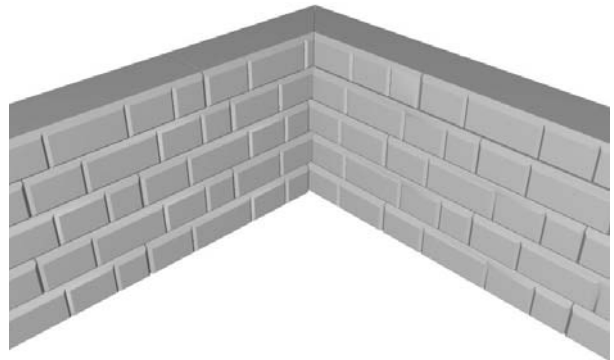

Reinforced Construction

For reinforced applications, the sheet of reinforcement must be extended a distance of 1/4 of the wall height past the back of the wall on the other side of the corner. Alternate the side on which the reinforcement is extended for successive layers of reinforcement. Also, never overlap the reinforcement in the joint between stacked SRW courses and ensure the leading edge of the reinforcement is placed within 25mm (1 in) of the face of the SRW units.

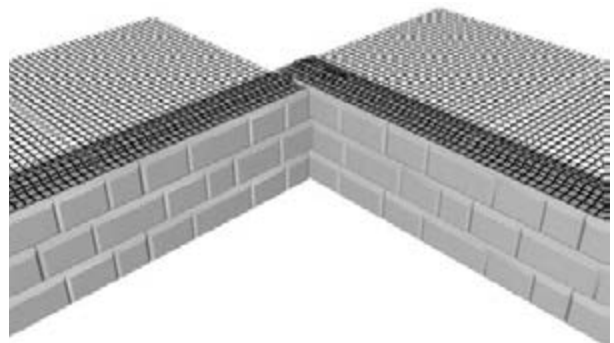

Crib Construction

Place units on base course leading to the corner. Continue placing base course units on adjacent wall, ensuring adjacent wall starts with tieback unit as shown.

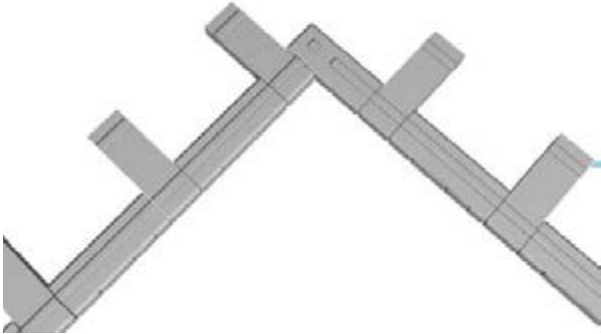

Commence second course by placing alternate corner unit to interlock corner. Place standard units and deadman units leading up to corner. Continue placing standard units and deadman units on adjacent wall to complete course.

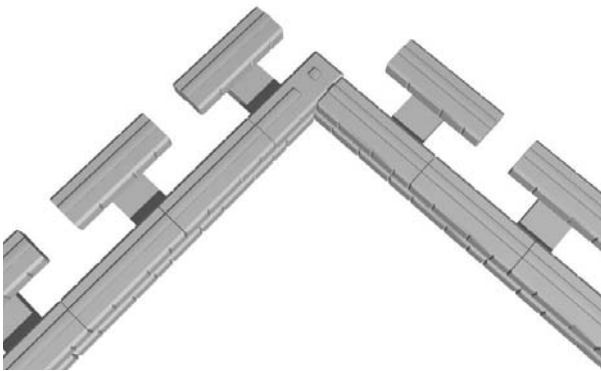

Alternate base course and second course construction techniques until desired wall height is achieved.

Making Modified Corner Units

To construct corners for any angle, other than those created using the manufactured corner units, you will need to make modified corner units as follows.

The tools you need to modify a unit include: tape measure, framing square, chalk, concrete saw, chisel and hammer.

Identify the necessary unit measurements from the table based on the angle of the corner. Decide if you are going to make a left or right modified corner unit. Use the appropriate diagram when measuring for your cut and face cut lines.

Measure the distances specified, on the front and back of the unit, and mark the SRW unit.

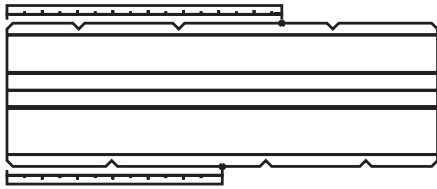

On one arm of the framing square mark the specified cut length. On the other arm mark the specified face cut length.

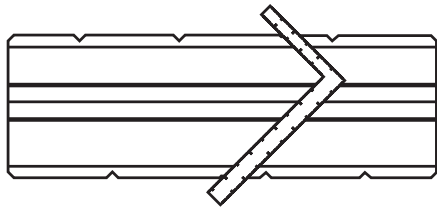

Align the marks on the framing square with the marks on the SRW unit. Trace the edge on the framing square to mark the unit. For inside corners, make sure the cut dimension is toward the front of the SRW unit.



Saw cut the unit along the cut and face cut lines to create a smooth square edge that will neatly abut the side of a standard unit. For inside corners, it is not necessary to cut the back piece off since it will be buried behind the wall.

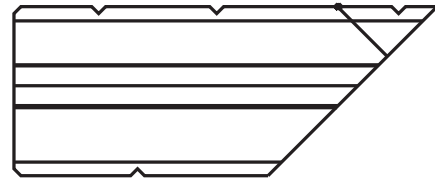

It will also be necessary to remove a portion of the key to allow the SRW unit from the next course to stack properly.

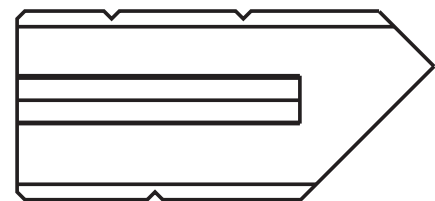
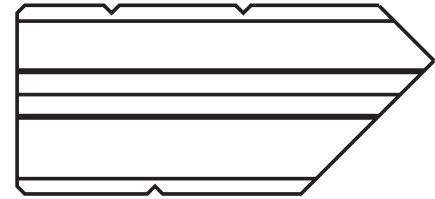

inside Corner – Metric Dimensions

Angle [degrees]	Front [mm]	Back [mm]	Back Cut *1 [mm]	Cut [mm]	Unit to modify
5	915	942	27	610	Standard
10	915	968	53	610	Standard
15	915	995	80	610	Standard
20	915	1023	108	610	Standard
25	915	1050	135	610	Standard
30	915	1078	163	610	Standard
35	915	1107	192	610	Standard
40	915	1137	222	610	Standard
45	Use manufactured 45° corner unit				
50	915	1199	284	610	Standard
55	915	1233	318	610	Standard
60	915	1267	352	610	Standard
65	915	1304	389	610	Standard
70	915	1342	427	610	Standard
75	915	1383	468	610	Standard
80	915	1427	512	610	Standard
85	915	1474	559	610	Standard
90	Use manufactured 90° corner unit				
91 – 180	Not Recommended				

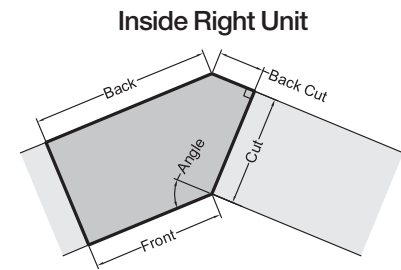
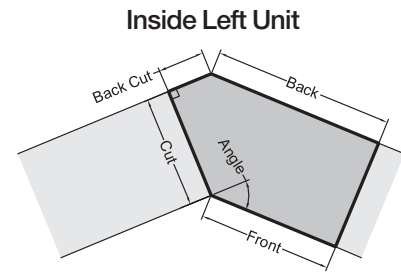

Inside Corner – Imperial Dimensions

Angle [degrees]	Front [inches]	Back [inches]	Back Cut *1 [inches]	Cut [inches]	Unit to modify
5	36	37 1/8	1	24	Standard
10	36	38 1/8	2 1/8	24	Standard
15	36	39 1/8	3 1/8	24	Standard
20	36	40 1/4	4 1/4	24	Standard
25	36	41 3/8	5 3/8	24	Standard
30	36	42 1/2	6 3/8	24	Standard
35	36	43 5/8	7 5/8	24	Standard
40	36	44 3/4	8 3/4	24	Standard
45	Use manufactured 45° corner unit				
50	36	47 1/4	11 1/4	24	Standard
55	36	48 1/2	12 1/2	24	Standard
60	36	49 7/8	13 7/8	24	Standard
65	36	51 3/8	15 1/4	24	Standard
70	36	52 7/8	16 7/8	24	Standard
75	36	54 1/2	18 3/8	24	Standard
80	36	56 1/8	20 1/8	24	Standard
85	36	58	22	24	Standard
90	Use manufactured 90° corner unit				
91 – 180	Not Recommended				

Notes

1 It is not necessary to cut the back piece for inside corners since the piece will not be seen



convex curve

The DuraHold system is able to create a 20m (66ft) radius with the tapered units on a convex curve; however, in preparation for the bottom course, remember that the radius will decrease by 38mm (1.5in) every course. Therefore, the smallest curve will result on the uppermost course. Adjustment to half tapered units may be necessary should vertical joints on successive courses start to line up.

Once the radius to be used is decided upon and the necessary curve for the base course is calculated, the base can be roughly outlined with spray paint. Upon completion of the base, the starting and ending points of the curve can be staked. The curve should be marked with paint to ensure the proper radius is established. If the base course is installed with too tight a radius, the upper courses may have to be cut to fit.



Place additional courses, remembering that the radius decreases by 38mm (1.5in) every course until desired height is achieved.



Geogrid layers should be placed within 25mm (1 in) of the front face of the unit. The geogrid will overlap and should have 75mm (3in) of compacted soil between layers. Geogrid should be placed on the units so the geogrid does not overlap until it enters the soil zone.

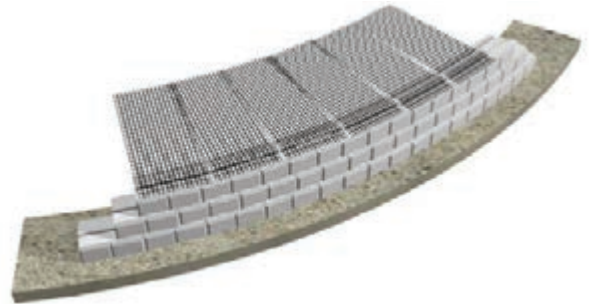

Repeat until desired wall height is achieved and place coping units as shown. DuraHold coping units must be saw-cut in order to create a curve. NOTE : Some manufacturers produce a half coping unit that may be used or altered to create a curve.



concave curve

For concave curves, the DuraHold standard units can create a minimum 20m (66ft) radius. The smallest radius will occur on the bottom course. Each additional course will result in a 38mm (1.5in) increase in the radius. Adjustment to half tapered units may be necessary should vertical joints on successive courses start to line up.

Once the radius to be used is decided upon and the necessary curve for the base course is calculated, the base can be roughly outlined with spray paint. Upon completion of the base, the starting and ending points of the curve can be staked. The curve should be marked with paint to ensure the proper radius is established.



Place additional courses, remembering that the radius increases by 38mm (1.5in) every course until desired height is achieved.

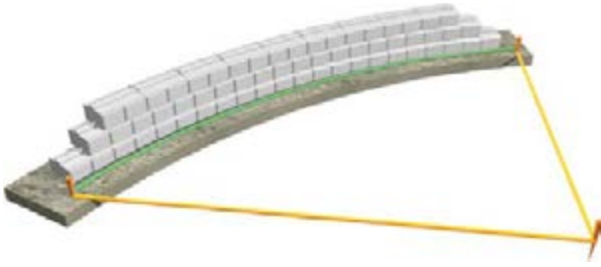

Geogrid layers should be placed within 25mm (1 in) of the front face of the wall. It will be necessary to have gaps between adjacent sections of geogrid. At alternating geogrid elevations the geogrid sections should be positioned so they overlap the gaps in the geogrid on the layers below.

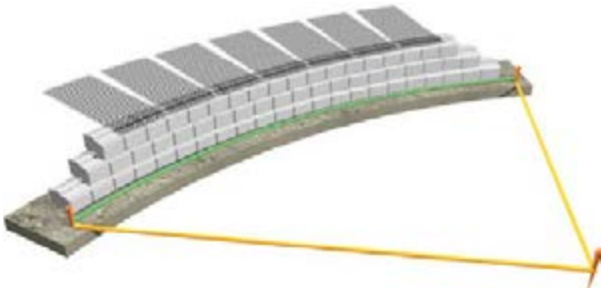

Repeat until desired wall height is achieved and place coping units as shown. DuraHold coping units must be saw-cut in order to create a curve. **[NOTE: Some manufacturers produce a half coping unit that may be used or altered to create a curve.]**

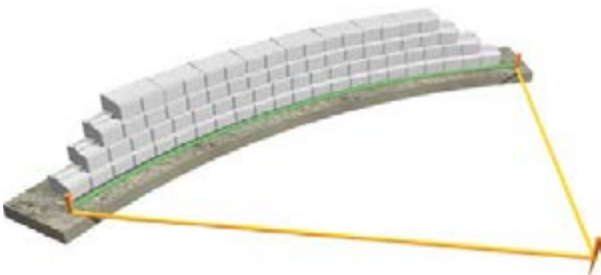



wood fences

Wood fences/acoustical fences may be constructed behind a DuraHold wall. These types of fences can pick up significant wind loads. The retaining wall must be designed to account for this additional loading and the fence typically can not be secured to the DuraHold retaining wall. Concrete forms, placed behind the wall, should be utilized to found the handrail/fence into the reinforced soil zone.

Loads created by pedestrians and/or wind on the fences must be incorporated into the geogrid design. As the concrete form depth increases, the additional lateral force generated in each geogrid is reduced. Wood/vinyl fences (solid) that take a wind load produce extremely high loads. Generally, foundations for these types of structures should extend more than the height of the fence into the reinforced soil, and the geogrid layout designed accordingly. Geogrid length to be determined by Designer.

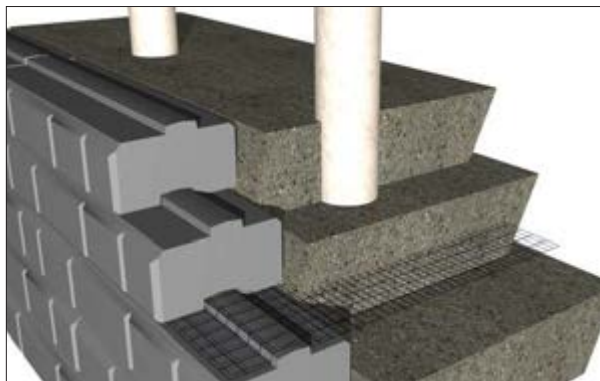

Construct the geogrid reinforced DuraHold SRW up to the elevation corresponding to the underside of the fence foundation.

Identify the proposed location of the solid fence foundations. Take into account the batter (setback) of the wall (25mm [1 in] per course) and the required offset at the top (It is preferable to leave a 300mm [12 in] buffer zone between the outside of the concrete form and the back of the wall. If this is not possible, expansion joint material must be placed between the back of the coping unit and concrete concrete form). Place the concrete form and fill around it to hold it in place. Continue stacking units, backfilling and compacting to 95% SPD until the next geogrid layer is reached.

Cut the geogrid perpendicular to the wall along the centerline of the concrete form, creating two geogrid panels – one on each side of the concrete form. Lay the geogrid flat in front of the concrete form. Secure the geogrid in place at the wall with the next course of units. At the intersection with the concrete form,

fold the geogrid flat against vertical side of the concrete form and then around the back, maintaining the edge of the geogrid along the centerline of the concrete form. Lay the geogrid flat behind the concrete form and pull taut. Secure the geogrid at the rear (with stakes) and continue placing fill.

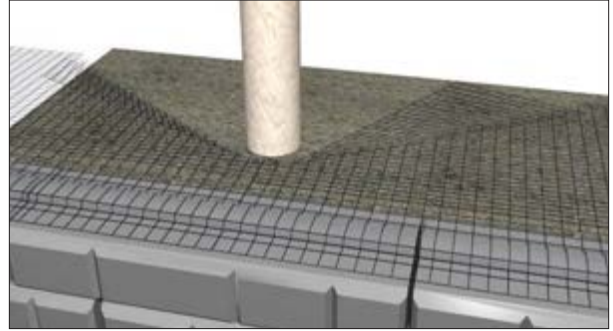

Repeat the previous step for each layer of geogrid encountered by the concrete form. Secure the coping unit and fold filter cloth back over drainage material. Cut filter cloth at centerline of concrete form to allow the concrete form through (similarly to method used to allow concrete form to penetrate geogrid layer), ensuring complete coverage of reinforced material. Cover concrete forms prior to concrete pour to prevent debris from entering.

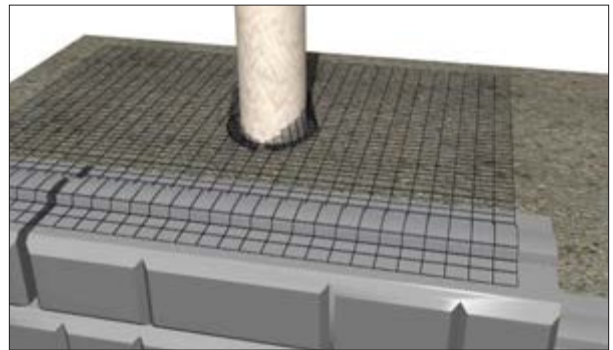

Pour concrete in foundations in accordance with fence design (reinforcing steel and/or dowels may be required). Install fence and finish grading.

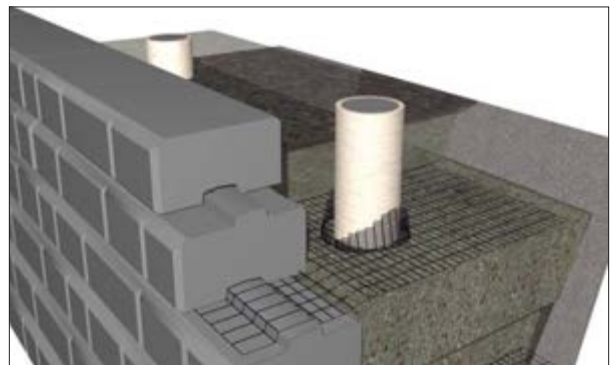

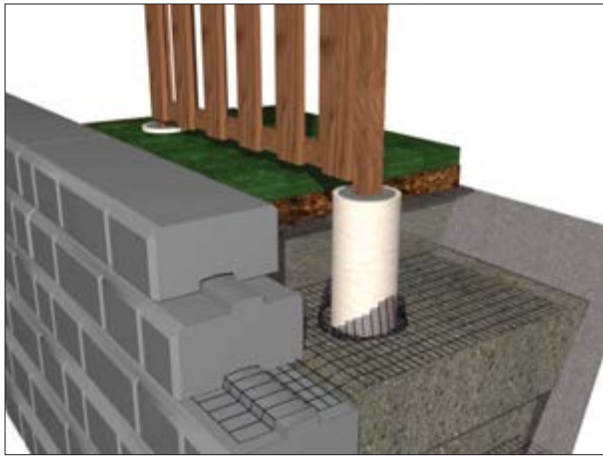

guardrails

For areas adjacent to roadways and parking lots, flexible steel beam guardrails may be placed behind a geogrid reinforced DuraHold SRW in accordance with the applicable governing standards. Additional “crash” loads must be accounted for in the design. Accepted procedures usually require the guardrail posts to be offset a minimum of 1m (3ft) from the back of the wall, extending a minimum of 1.5m (5ft) into the reinforced zone. We recommend that the posts be placed as the wall is constructed (refer to handrail construction) and compaction surrounding the posts be carefully monitored to ensure optimum confinement.

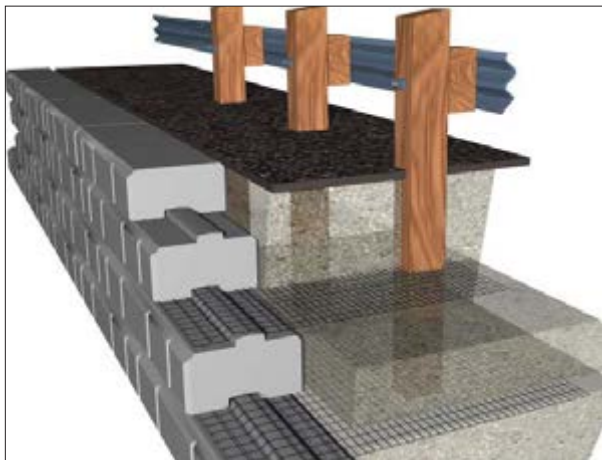

pedestrian handrail/chainlink fence

Chainlink fences and pedestrian handrails (not wind bearing) may be attached directly to the DuraHold wall. In order to resist the required loads, the post (maximum diameter 100mm [4in]) must be core-drilled a minimum of 450mm (18in), and be secured with **non-expansive grout**. (Non-shrink grout: follow manufacturer’s recommended installation procedures. Use of expansive grout will cause failure of the units.) The holes are to be drilled a minimum of 250mm (10in) from the front face of the wall with a maximum post separation of 2430mm (96in).

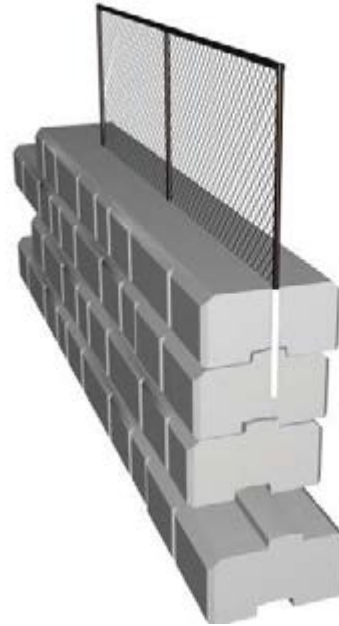



catch basin

Take the following steps when a catch basin is interfering with the placement of the geogrid reinforcement as specified by the site design. Select an appropriately sized steel pipe with a length of at least twice the width of the catch basin. This pipe will be used to tie back the section of wall adjacent to the catch basin. Start by constructing the wall up to the elevation of the first layer of geogrid.

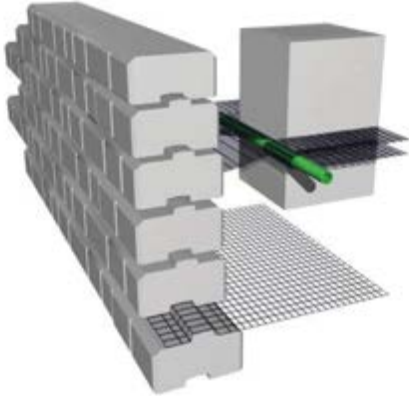

Area Adjacent to Catch Basin:

1. Cut a layer of geogrid to a length equal to twice the depth from the front face of the wall to the catch basin plus 200mm (8 in).
2. Lay the geogrid on the specified course and secure it by placing the next course.
3. Pull the geogrid back towards the catch basin. Lay the steel pipe on top of the geogrid and pull the remaining length of geogrid up away from the pipe.
4. Fill to the top of this course and pull the remaining geogrid back over the reinforced zone towards the wall. Lay the geogrid flat on top of the most recently placed course and secure in place with next course.

Area on Either Side of Catch Basin:

Instead of tying the facing to the pipe, tie the pipe back into the reinforced zone as described above, ensuring a minimum of 150mm (6 in) of compacted fill material between the top and bottom layer of geogrid.

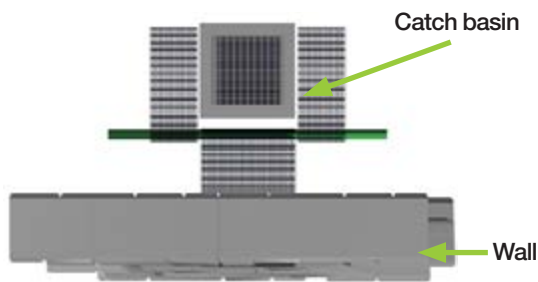

structures

Retaining walls constructed near structures must be placed outside the zone of influence of the footing as required by the Geotechnical Engineer (typically a 7V:10H influence line). If there is a space limitation, it may be necessary to underpin the foundation of the structure.

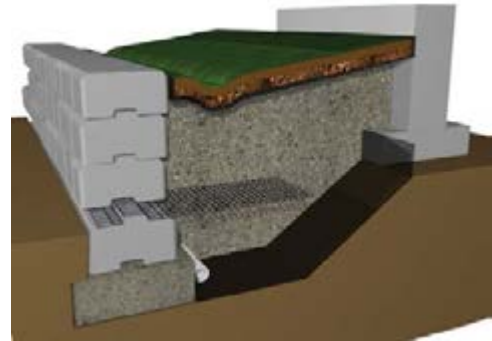

trees

When planting trees or shrubs behind DuraHold walls, a few steps must be taken to ensure the stability of the wall. The root ball should only impact the top two layers of the geogrid reinforcement. The geogrid should be cut perpendicular to the wall along the centerline of the root ball, placed flat and at the intersection with the root ball folded up the sides around to the back, maintaining the edge of the geogrid along the centerline of the root ball. Small trees (max. 0.915m [3ft]) may be placed a minimum of a 1.5m (5ft) from the face of the wall. Larger trees (max. 1.8m [6ft]) are to be placed a minimum of 3m (10ft) from the face of the wall. These distances are required to avoid root growth into the DuraHold units and to reduce the wind loading effects caused by the trees. If multiple trees are to be planted, a qualified Engineer should be contacted to assess the impact of the geogrid cuts. A root barrier may also be required to avoid root growth towards the DuraHold wall and drainage layer structures.





Proper drainage of a segmental retaining wall is one of the most critical aspects of design and construction. Unless otherwise stated, the design assumes that no hydrostatic pressures exist behind the wall. To ensure this condition is met, water flow from all directions and sources must be accounted for in the design through proper grading and drainage measures, diverting water away from the wall whenever possible.

The following table is provided to address general concepts of drainage. Refer to the NCMA Drainage Manual for an in-depth discussion of and recommendations for drainage.

internal drainage

We have created this chart to explain and illustrate the four different internal drainage possibilities.

Depending on anticipated groundwater elevations, blanket and chimney drains may also be required. Refer to the NCMA Drainage Manual for further information.

Non-Well-Draining Reinforced Zone

If the fill material being used to construct the reinforced zone is not considered to be well draining (>8% fines), a drainage layer is required immediately behind the face of the wall. The drainage material must be a minimum of 300mm (12 in) thick, composed of a gap-graded, free-draining, angular clear stone (19mm [¾ in]). An approved filter cloth must be placed between the drainage layer and the fill material to prevent the migration of fines and contamination of the drainage material. At each geogrid layer, the filter cloth must be pulled back into the reinforced zone a minimum of 150mm (6 in) and cut. The drainage layer must be fully encapsulated with a 150mm (6 in) overlap at each geogrid elevation as shown.

Well-Draining Reinforced Zone

As the construction of a separate drainage layer immediately behind the facing units can be cumbersome and reduce efficiency, a popular option is to use a free-draining, granular material for the reinforced zone. It is recommended that this material be well-graded, with less than 8% fines. An approved filter cloth should be placed between the reinforced zone and retained and foundation soil to prevent the migration of fines. The use of an imported granular material in the reinforced zone has many other advantages besides its good drainage properties (see *Specifications – Soils*).

Outlet to Catch basin / Drain

If the drain is being connected to a catch basin or other drainage outlet, it should be located at the lowest elevation possible. Placing the drain at the founding elevation ensures better drainage of the base and subsoils. A minimum 2% slope is recommended.

Outlet locations must be planned in advance by the Civil Engineer as part of the overall drainage plan for the site.

Outlet Through Face

If the drain is being outlet through the face of the wall, it is recommended that an approved, less pervious engineered fill material be compacted under the drain up to the grade in front of the wall. This measure collects water percolating through the reinforced zone and directs it to the drain, rather than allowing the base to become saturated. The outlet pipe should be a non-perforated PVC (connected through a T-joint) placed a minimum of 15.0m (45ft) on centre (or as required by the design). The DuraHold unit may be cut and shifted over as required to allow the pipe to be outlet. It is recommended that the area around the pipe be grouted to prevent the washout of fine soil particles. A concrete splash pad at the outlet pipe locations is recommended if large water flows are anticipated.

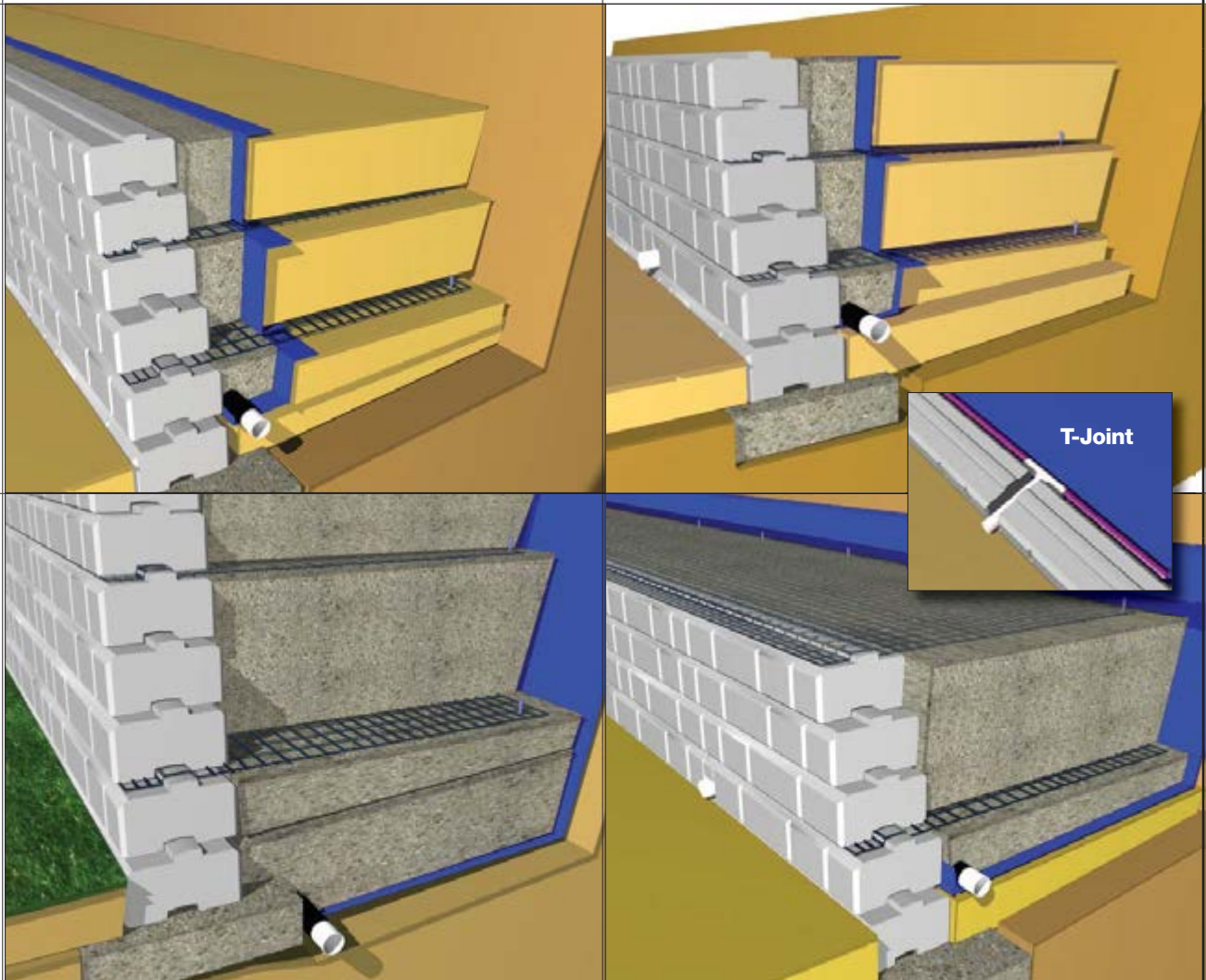



swales

Surface water run-off should be diverted away from the retaining wall to help prevent the build up of hydrostatic pressures behind the wall. This can be achieved by providing a swale with a minimum gradient along the length of the wall of 2%.

Clay Swale

A 100mm (4 in) top soil layer may be underlined with a 100mm (4 in) low permeability clay soil to divert the surface runoff. The top soil layer is to support the growth of vegetation that provides erosion protection for both the top soil and clay layers. The slope directly away from the wall helps to ensure that water is not given a direct route into the drainage material if settlement occurs. A filter fabric should be placed between the clay layer and fill material to prevent the migration of fines.

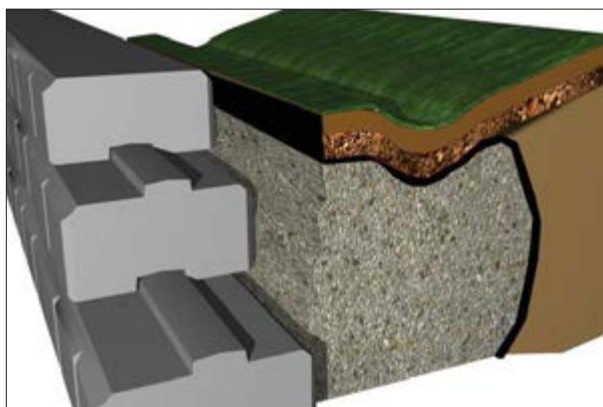

Concrete Swale

A 100mm (4 in) concrete or asphalt swale may be used to divert surface runoff. A 25mm (1 in) expansion joint should be placed between the concrete and the back of the retaining wall. Heavy paving equipment should be kept a minimum of 1m (3ft) away from the wall to prevent movement of the top courses.

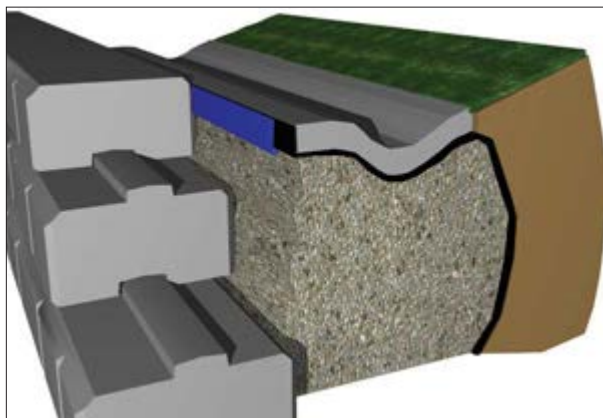

blanket / chimney drains

Where high groundwater flows are anticipated, the use of blanket drains (drainage layer extended horizontally along the base of the wall) or chimney drains (drainage layer extended up the back of the reinforced zone to intercept groundwater flows) prevent infiltration in the DuraHold structure. A drainage composite material can be very effective when used to construct a chimney drain.

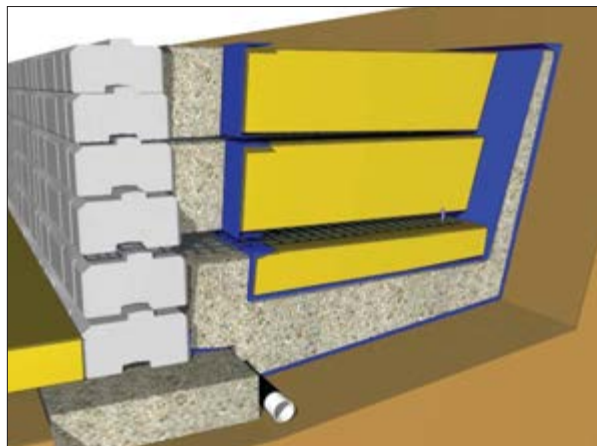

water applications

DuraHold geogrid reinforced and crib segmental retaining walls may be used in water applications such as lake/river shorelines and detention ponds. A number of additional issues must be considered when designing and constructing in this type of application, such as erosion of the base/foundation, wave effects, perched water conditions, and ice effects.

The DuraHold wall analysis must incorporate the effects of buoyant unit weights, rapid draw-down conditions, etc. when determining geogrid length, type, and placement. The required wall embedment normally increases as the potential for erosion becomes a factor. A minimum 600mm (2.0ft) embedment is standard practice. As well, rip-rap or other forms of erosion protection at the bottom of the wall may be required.

The footing may be concrete or standard granular wrapped in a woven geotextile to prevent washout. If the potential for rapid draw-down (water level falling quicker in front of the wall than the reinforced fill material will allow) exists, the reinforced fill material must be chosen to reduce the effects. It is recommended that a clear-stone drainage layer be used in conjunction with a well-graded, free-draining, granular reinforced zone. The filter cloth used between the drainage layer and reinforced zone should be selected taking into account the filtration characteristics of the two types of granular materials.

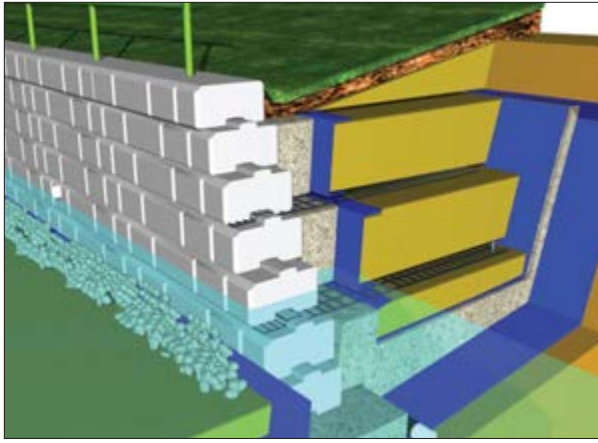

The placement of drains is based on the anticipated normal and high water levels. An outlet through the wall face should be placed above the normal and high water levels at maximum 15m (45ft) on centre. If the groundwater level is expected to fall below the foundation elevation, an additional drain should be added at this level. As well, a chimney or blanket drain may be required depending on conditions.

If ice or wave effects are anticipated, rip-rap protection must be designed accordingly.

box culverts and headwalls

The key point in building this type of wall is to structurally separate the DuraHold wall from the concrete headwall. Essentially, the DuraHold wall must be constructed as three separate structures, allowing any potential differential settlement to occur without distress in the face. The walls must be abutted tightly with a 25mm (1 in) expansion joint separating them and the headwall.

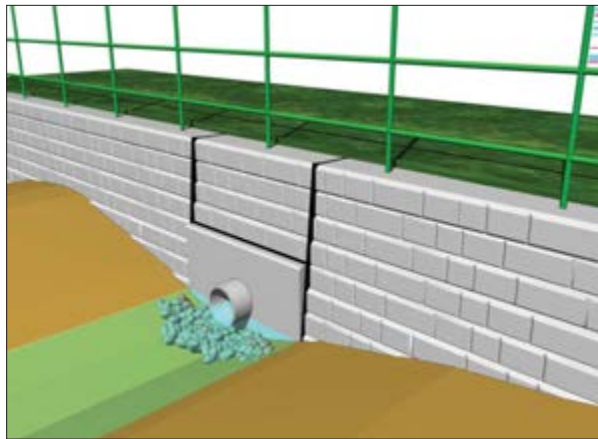

These pictures show the bottom of DuraHold units resting on top of the headwall. However, this may not actually happen on site. A layer of mortar may have to be used to raise the elevation of the headwall to ensure that the courses line up on the adjacent sections of wall.



round culvert through wall

A culvert may be outlet through the face of the wall, providing the pipe has been designed to withstand the load of the wall above it and no excessive settlement is anticipated which may alter the alignment of the pipe. Once these issues have been addressed, the DuraHold units can be cut to fit on site. A 25mm asphalt-impregnated fibre board expansion joint should be placed around the pipe to ensure a tight fit and prevent the reinforced fill from washing out. Rip-Rap is also required to protect the base from washout.

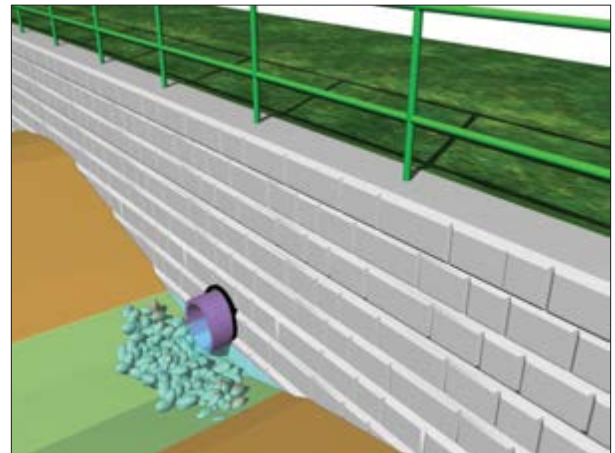

As the diameter of the culvert increases it may be easier to construct a head wall at the end of the culvert and assemble the wall using the box culvert details.



Note: As the dimensions of a DuraHold coping unit are slightly larger than a standard step, it is recommended that SienaStone coping units be used as steps (as shown).

inset

Start with two outside 90° corner sidewalls. The walls are separated by the required step width. The side walls can be built in either battered or vertical arrangement, as specified in the design. If side walls are battered, the step width (base extended to constant elevation) must be adjusted to meet wider distances between the side walls as each course steps back. The side walls can be constructed on a level foundation elevation as shown in the drawing or stepped up to follow the grade change created by the steps. If the side walls are stepped up, make sure a minimum of one course of sidewall units is embedded.



Using SienaStone coping units as the steps, place the first course on the same elevation as the side walls. [Note: coping units may require modifications to fit the distance between the side walls. If the overall distance is more than 1000mm (39in), two coping units are required and a running-bond pattern must be achieved when placing upper steps.] Then, place the granular materials at the back of the first step units at the same top elevation after compaction.



Using a cement-stabilised aggregate can help to minimise future settlement issues.

Repeat the previous stage to build the steps up. The tread depth can be set from 500mm (20in) to almost any smaller dimension.



Repeat the previous stage to finish the steps as shown in the drawing.



Core drill handrails as specified in the design.



protruding

Start the wall with two inside 90° corners. The sidewalls must be constructed vertically. Use a SienaStone coping unit to achieve the first riser step. [Note: Depending on step width, coping units may need to be cut to achieve desired width of steps.] Then place the granular materials at the back of the first step units at the same top elevation after compaction.

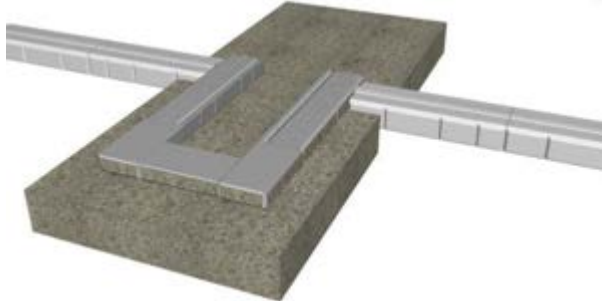

Repeat the previous stage for the second course. Ensure the step depth is as specified in the design.

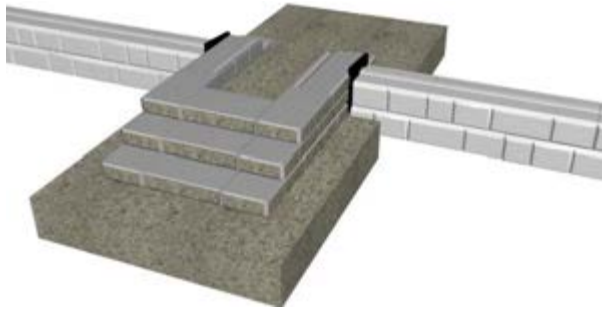

Repeat the previous stages to finish the steps as shown in the drawing. [Note: Coping units at the side walls may require modifications to fit the reducing length of the side walls.]



Core drill handrails as specified in the design.

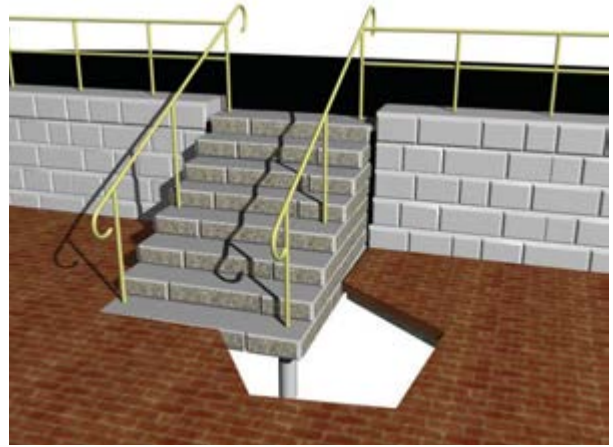



conventional SRWs

If done correctly, terracing can be an effective way to reduce loading and gain greater overall height, while still maintaining an aesthetic appearance.

Generally, a good rule of thumb is to set the distance from the back of the lower wall to the face of the upper wall to be greater than the height of the lower wall. [NOTE: For crib structures, this distance is to be referenced from the back of the crib structure (i.e. either 1830mm [72in] or 3050mm [120in]). If there is a slope between the two walls, this separation will need to be increased.

It is recommended that a qualified engineer review the terraced SRW design and site soil conditions, specifically checking the global stability of the proposed structure.

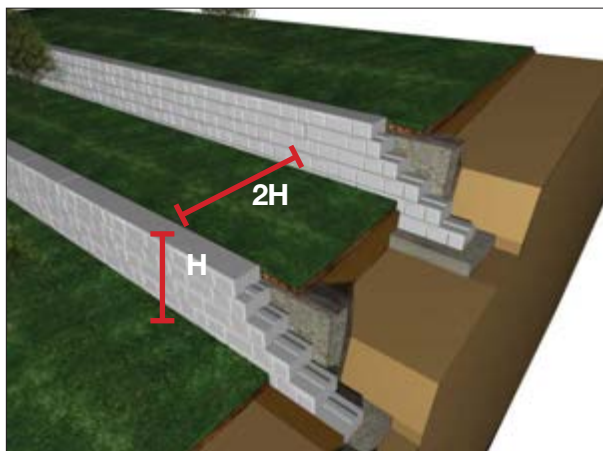

reinforced SRWs

Reinforced SRWs can be designed to support upper terraces that are in close proximity to the back of the wall. Generally, the further the upper wall(s) are offset from the top of the lower wall, the less expensive the construction will be. Once a minimum offset distance is established in the design, this must be adhered to throughout the structure.

The loads produced by terraced walls can be great. As an example, a small 0.6m (2.0ft) high wall produces a load equivalent to a heavy traffic surcharge on the lower wall. These loads may be reduced by increasing the separation between the walls or increasing the foundation depth of the upper wall. Wherever possible, the lower wall should be higher than the upper wall.

It is recommended that a qualified engineer review the terraced SRW design and site soil conditions, specifically checking the global stability of the proposed structure.





Typically it is inadvisable to end any retaining wall abruptly. If proper care is not taken at the ends of the wall, the fill material may be eroded, leading to undesirable settlement and possible failure. There are several ways to finish off the end of a retaining wall:

90° return end

A corner (90° shown) could be constructed to run the wall into the slope that is being retained, thereby containing the granular material behind the wall.



stepped down end

The wall could be extended and stepped down to a reasonable height to allow the ground to be graded around the wall end.



abut existing structure

The wall could be abutted to an existing structure. This would involve cutting the retaining wall units in order to maintain the running-bond pattern. An expansion joint (25mm [1in] asphalt-impregnated fibreboard) should be placed between the retaining wall and the structure. This will allow the wall to move slightly while still containing the granular material. Note that if the existing structure's footing extends under the retaining wall for a short distance, this could lead to differential settlement and in turn, cracking of the SRW units or separation between the units.

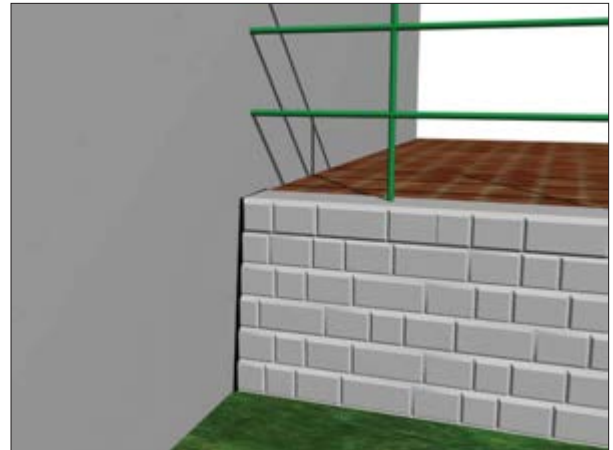



Since 1974, innovation has been a way of life for Risi Stone Systems. Today, Risi Stone Systems' retaining walls are the products of choice for landscape, construction and municipal projects internationally.

The patented components, developed by Risi Stone Systems, have been licensed to concrete producers in major markets throughout the world. These producers employ the latest computer and robotic technology in the production of the finest modular concrete retaining wall system.

For more information on the right product for your project, visit our website

www.risistone.com
or contact us at 1.800.626.WALL • info@risistone.com

Manufactured under licence from



RisiStone
retaining wall systems

The proprietary products and designs described herein are covered under one or more of the following: US Pat. 4,815,897 • US Pat. 4,490,075
US Pat. 5,622,456 • US Pat. 5,064,313 • US Pat. D 403,437 • US Pat. D 403,785 • US Pat. D 370,272 • Cdn. Pat. 1,182,295 • Cdn. Pat. 1,204,296
Cdn. Pat. 2,145,344 • Cdn. Pat. 2,017,578 • Ind. Des. 83,773 • Ind. Des. 78,184.
Other domestic and foreign patents and designs are pending.